



# Table of contents

Package contents.....	2
Getting started.....	3
Description of the device.....	4
Connecting to a WiFi network.....	6
The Android™ interface.....	8
Archos Mapping Tool.....	12
Getting familiar with Android™ .....	18
Troubleshooting.....	20

For more information, please consult the FAQs on [www.archos.com](http://www.archos.com). Make sure to read them before considering any product return. Your deal may be no big deal. As we are often updating and improving our products, your device's software may have a slightly different appearance or modified functionality than presented in this Quick Start Guide.



# Package contents

---

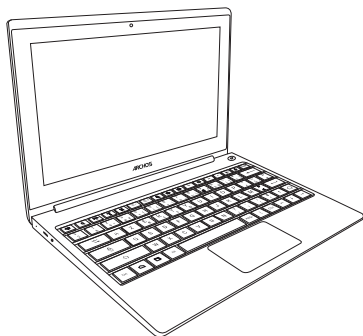

ARCHOS ArcBook



QSG booklet



Warranty,  
legal & safety booklet



USB cable

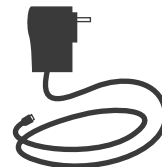

Charger





# Getting Started

## Charging

Connect the supplied power cable to the ARCHOS and to a wall outlet.

The ARCHOS device will turn on and start charging.

The charging indicator light is red while the battery is charging.

It will turn blue when the battery is fully charged.

<b>When the device is off</b>	Press the ON/OFF button to turn it on.
<b>When the device is on</b>	<ul style="list-style-type: none"><li>- Short press the ON/OFF button to turn it in sleep mode</li><li>- Long press the ON/OFF button to display options and select to turn it off</li></ul>

### TIPS:

You can use your ARCHOS whilst it charges. Let your device charge completely the first time you use it. Use only the supplied charger.

To receive more complete service, please register your product. From a computer, go to [www.archos.com/register](http://www.archos.com/register).



# Description of the device

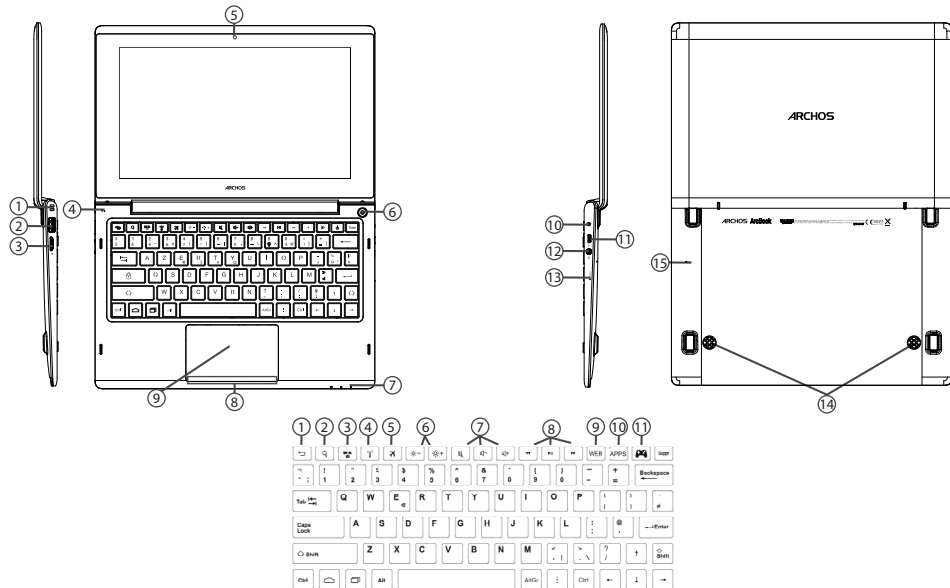



### Device connectors

- |                      |                      |                  |
|----------------------|----------------------|------------------|
| ① Locking hole       | ⑥ ON/OFF button      | ⑪ Micro-USB port |
| ② USB port           | ⑦ Charging indicator | ⑫ Headphone jack |
| ③ Micro-SD card slot | ⑧ Touch panel button | ⑬ Restore button |
| ④ Microphone         | ⑨ Touch panel        | ⑭ Loudspeakers   |
| ⑤ Webcam             | ⑩ Power connector    | ⑮ Reset button   |

### Keyboard shortcut buttons

- |                       |                        |               |
|-----------------------|------------------------|---------------|
| ① Back button         | ⑤ Airplane mode button | ⑨ WEB button  |
| ② Search button       | ⑥ Brightness buttons   | ⑩ APPS button |
| ③ Notification button | ⑦ Volume buttons       |               |
| ④ WiFi button         | ⑧ ARCHOS Music buttons |               |

# Connecting to a WiFi Network

CAUTION: Make sure that you are in a WiFi zone.



① Touch and hold the time & battery icons to reveal the status bar. A blue line is displayed.



② Pull the blue line down to display the status dashboard.



③ Touch "WiFi off" in the status dashboard. The WiFi page will be displayed.



④ Slide the WiFi switch to "ON" position.

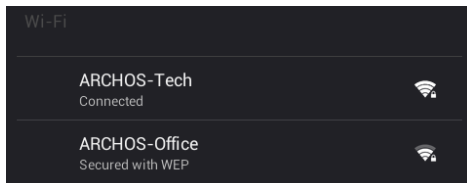



⑤ The ARCHOS will scan for WiFi networks in range. Touch the name of network you want to connect to. Private networks are shown with a lock icon and will require you to enter your password.

## Quick connection

You can connect to your WiFi network through WiFi Protected Setup.

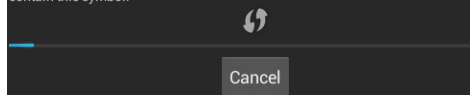
Press the WiFi Protected Setup button on your router. It may be called "WPS" or contain this symbol:



- ① Press the WiFi Protected Setup button  in Settings > Wireless & networks.
- ② In your Internet router, Press the WiFi Protected Setup button called WPS or containing the symbol .

### TIPS:

- When entering a WiFi password, we recommend that you select "Show password" so you can see the characters you are typing. To get the correct WiFi password (or settings) for the network, contact the WiFi network provider. If your WiFi is on and you are in range of a network that you previously connected to, your ARCHOS will automatically attempt to connect to it.
- To keep your WiFi connection ON when the device is on sleep, select the Menu icon in the "WiFi" page. Then, select Advanced > Keep WiFi on during sleep > Always.

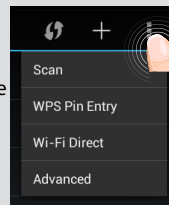

# The Android™ Interface







- ① **Android™ apps shortcuts**  
> Touch to start an application.
- ② **Permanent Android™ apps shortcuts**  
> Touch to start an application
- ③ **Back button**
- ④ **Home button**
- ⑤ **Recent apps buttons**
- ⑥ **Archos mapping tool icon**
- ⑦ **All Apps button**  
> Touch this icon to show all the applications and widgets installed on your ARCHOS. All your downloaded applications are here.
- ⑧ **Google™ Search**  
>Touch "Google" for text search or touch the microphone icon for voice search.
- ⑨ **The status bar**  
> Displays notifications and quick settings

# The Android™ Interface

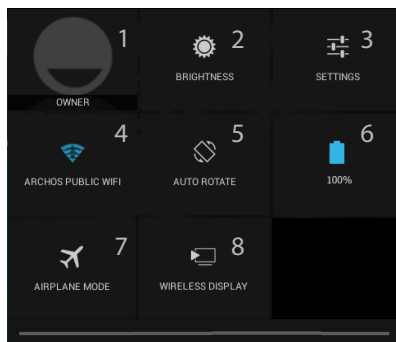

## 3:18 The Quick settings

- 1 Current user<sup>(1)</sup>
- 2 To adjust the screen brightness.
- 3 To access all your settings.
- 4 To turn on/off your WiFi connection.
- 5 To activate/deactivate automatic screen orientation as you turn your ARCHOS.
- 6 Percentage of battery remaining
- 7 To activate/deactivate all wireless connections, especially when flying.
- 8 To enable wireless display<sup>(2)</sup>

<sup>(1)</sup>New multi-user support for tablets lets different users have their own separate, customizable spaces on a single device. Add users in Settings > Device.

<sup>(2)</sup>You can share movies, YouTube videos, and anything that's on your screen on an HDTV. You need to connect a wireless display adapter to any HDMI-enabled TV to mirror what's on your screen quickly and easily.

## The Recent Apps

Opens a list of thumbnail images of apps you've worked with recently:

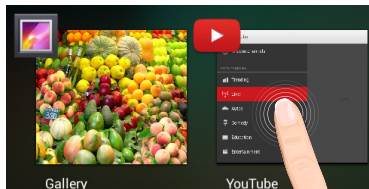

**Touch:** to open an app.

**Hold down:** to display options

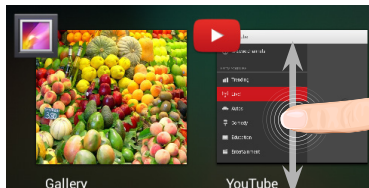

**Swipe up or down:** to close an app.

# ARCHOS mapping tool

ARCHOS mapping tool is an application installed in your ArcBook. It allows you to link the virtual controls of games to the physical controls of the ArcBook by using mapping controls.



## Tip 1:

Within ARCHOS mapping tool, there are already mapping profiles for over 100 games. Also, many games function automatically with physical buttons.

## Tip 2:

Whenever you launch a game whose virtual controls are mapped, the right mapping profile will automatically be selected.

## Starting ARCHOS mapping tool

1. Launch a game.

When you reach the starting screen, the virtual controls are displayed.

2. Select the ARCHOS mapping tool icon from the system bar.



The mapping overlay is displayed with the mapping tool interface.

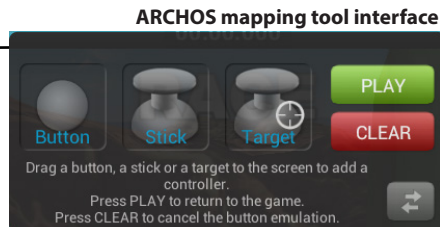

# ARCHOS mapping tool

## Positioning a mapping control

Hold and drag a type of mapping control to the desired virtual button.

There are three types of mapping control



Button

It is for the directional pad ◀, ▶, ▼, ▲, the X, Y, B, A, buttons and the L1, R1, L2, R2, Start, Select buttons.



Stick

It is for the analog directional sticks.



Target

It is for analog stick targetting. It is placed normally in the central area of the screen on shooting games.

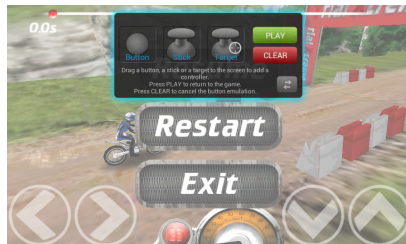



## Linking a mapping control to a physical control

1. When a mapping control is placed on a virtual control, you are asked to select the desired physical control you want to associate with it.

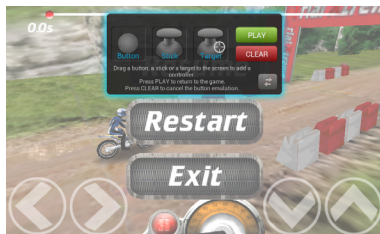

2. Once a physical control is associated to the mapping control, the name of the physical control is displayed on the mapping control.





# ARCHOS mapping tool

## Enlarging a mapping control

Some virtual controls are larger than the mapping controls.

Enlarge the mapping control so that it is tailored to the virtual control.

1. Resize with right analog stick.
2. Press button A when done

You can only enlarge the mapping controls Stick and Target.

## Saving your parameters

When you have mapped the virtual controls of a game, select "Play"  to validate .

The profile is saved and associated with that game.

The mapping overlay disappears and you can play.

Whenever you start the game, you are informed that the emulation of virtual controls is running. Each mapping is specific to a game.

Press the notification to display the mapping profile of the game. You can either modify it, or delete it.



## Q&A about the mapping

You placed a mapping control on a virtual control but no option is available?

1. Tap the mapping control.

A menu box is displayed.

2. Select the  icon to set up the mapping control.

You want to remove a mapping control that you set?

1. Tap the mapping control.

A menu box is displayed.

2. Select the  icon to remove the mapping control.

You want to remove a mapping profile set for a game?

1. In the interface of the Game, select the mapping tool icon.

2. From ARCHOS mapping tool, select "Clear".

3. Select "OK" to confirm.

### Displaying options

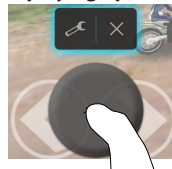

### Removing a mapping profile

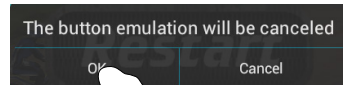
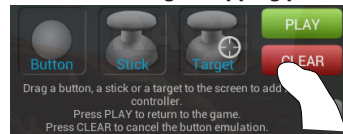



# Getting familiar with Android™

---

You can use your device as a regular computer with the keyboard and touch panel or you can interact with touchscreen.

## **Using the Touch Panel:**

To do a short press: tap the Touch Panel once.

To do a long press: hold the Touch Panel button

## **The extended home screen:**

**Finger:** Navigate between different home screen panels by swiping left and right.

**Touch Panel:** Hold the Touch Panel button while moving the cursor with the Touch Panel

## **Moving a home screen item:**

**Finger:** Touch and hold your finger onto it until the positioning gridlines appear, then slide it to the desired location, and release your finger.

**Touch panel:** Select the item with the cursor and hold the Touch Panel button. While holding the Touch Panel button, use the Touch Panel to move the item.

## **Removing a home screen item:**

**Finger:** Touch and hold it, slide your finger towards the top of the screen and drop it over the "Remove" icon.

**Touch panel:** Select the item with the cursor and hold the Touch Panel button. While holding the Touch Panel button, use the Touch Panel to move it towards the top of the screen and drop it over the Remove icon X.

## **Uninstalling an item:**

**Finger:** From the "All apps" screens, touch and hold it, slide your finger towards the top of the screen and drop it over "Uninstall" bin.



**Touch panel:** From the "All apps" screens, select the item with the cursor and hold the Touch Panel button. While holding the Touch Panel button, use the Touch Panel to move it towards the top of the screen and drop it over the Bin icon.

**Creating application folders:**

Drop one app icon over another on a home screen and the two icons will be combined.

**Widgets:**

Touch the "All Apps" icon on your home screen. Touch "Widgets" at the top of the screen. From the main Widget screen, you can move around widgets just as you do for app icons.

**Changing your wallpaper:**

**Finger:** Hold your finger on a home screen at an empty location, then choose from the list.

**Touch panel:** On an empty space of the homescreen, hold the Touch Panel button.

**Locking the touchscreen:**

From the quick settings dashboard in the status bar, touch "Settings". In "Settings", scroll down and touch "Security". Touch "Screen lock". Touch the type of lock you would like to use. After you set a lock, a lock screen is displayed whenever your screen wakes up, requesting the pattern, pin or other specified key.

**Opening ARCHOS Music app**

Long press on the Play/Pause shortcut button on the keyboard.



# Troubleshooting

---

## **If your device is frozen:**

Press the ON/OFF button for 10 seconds or use the reset button. To use the reset button, press the “pinhole reset” button by using a sharp object such as a toothpick.

## **If your device doesn't turn on:**

1. Charge your device.
2. Press the ON/OFF button for 10 seconds or use the reset button. To use the reset button, press the “pinhole reset” button by using a sharp object such as a toothpick.

## **If you want to extend the life of your battery:**

Decrease the screen brightness and turn off the wireless connections if not in use.

## **If your device functioning is too slow:**

Close all apps which are not currently used.

## **If your WiFi reception is too low:**

Make sure you are not far from the WiFi hotspot.

Update the firmware of the device: <http://www.archos.com/support>.

Reset and redefine your connection parameters.

Contact your WiFi connection provider.

## **If you want to restore your product (forgotten password? erase all your settings?) :**

1. Insert a paper clip in the Restore button.
2. While holding the paper clip, connect the plugged power cable to the ARCHOS.

The device turns on. The Android system recovery is displayed.



# Table des matières

Contenu de la boîte.....	22
Mise en route.....	23
Description de l'appareil.....	24
Se connecter à un réseau WiFi.....	26
L'interface Android™.....	28
L'ARCHOS mapping tool.....	32
Se familiariser avec Android™.....	38
Dépannage.....	40

Pour plus d'informations, consultez les FAQs sur [www.archos.com](http://www.archos.com). Consultez-les avant d'envisager un éventuel retour du produit. Le problème que vous rencontrez peut être résolu facilement. Comme nous mettons à jour et améliorons régulièrement nos produits, le logiciel de votre appareil peut présenter une interface ou des fonctionnalités légèrement différentes de celles décrites dans ce guide.





# Contenu de la boîte

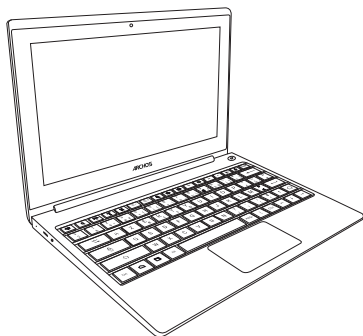

ARCHOS ArcBook



Guide d'utilisation  
rapide



Guide des garanties et  
des mentions légales

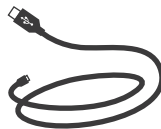

Câble USB

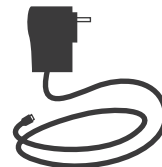

Chargeur





# Mise en route

## Charger la batterie

1. Branchez le câble d'alimentation fourni sur le connecteur d'alimentation de la tablette et sur une prise secteur. Votre appareil s'allume et commence à se charger.

Le témoin de charge est rouge lorsque la batterie est en charge.

Il est bleu lorsque la batterie est complètement chargée.

### Lorsque l'appareil est éteint

Appuyez sur le bouton ON/OFF pour l'allumer

### Lorsque l'appareil est allumé

- Appui court sur le bouton ON/OFF pour mettre l'appareil en veille
- Appui long sur le bouton ON/OFF pour afficher les options, puis sélection de l'option pour éteindre

### ASTUCES:

Vous pouvez utiliser votre tablette pendant le chargement de la batterie. Lors de la première utilisation, chargez complètement la batterie de la tablette. Utilisez uniquement le chargeur fourni.

Pour bénéficier d'une assistance complète, enregistrez votre produit. A partir de votre ordinateur, allez sur [www.archos.com/register](http://www.archos.com/register).



# Description de l'appareil

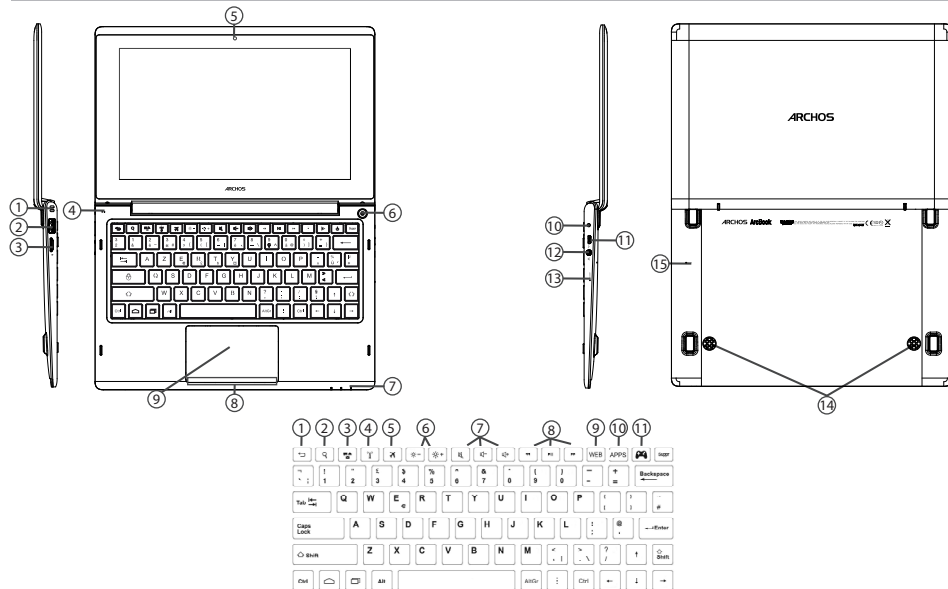





## Connecteurs de l'appareil

- |                          |                             |                                 |
|--------------------------|-----------------------------|---------------------------------|
| ① Trou de verrouillage   | ⑥ Bouton ON/OFF             | ⑪ Port micro-USB                |
| ② Port USB               | ⑦ Témoin de chargement      | ⑫ Entrée jack audio             |
| ③ Lecteur carte micro-SD | ⑧ Bouton du pavé tactile    | ⑬ Bouton de restauration totale |
| ④ Microphone             | ⑨ Pavé tactile              | ⑭ Haut-parleurs                 |
| ⑤ Webcam                 | ⑩ Connecteur d'alimentation | ⑮ Bouton de réinitialisation    |

## Boutons raccourcis du clavier

- |                        |                          |               |
|------------------------|--------------------------|---------------|
| ① Bouton Retour        | ⑤ Bouton Mode Avion      | ⑨ Bouton WEB  |
| ② Bouton Recherche     | ⑥ Bouton Luminosité      | ⑩ Bouton APPS |
| ③ Bouton Notifications | ⑦ Boutons de volume      |               |
| ④ Bouton WiFi          | ⑧ Boutons ARCHOS Musique |               |

# Se connecter à un réseau WiFi

ATTENTION : assurez-vous d'être dans une zone WiFi.



① Sélectionnez les icônes Heure et Batterie en maintenant votre doigt appuyé afin d'afficher la barre de statuts.



② Tirez vers le bas la barre bleue pour afficher le panneau des statuts.



③ Sélectionnez "WiFi éteint" dans le panneau des statuts. L'écran "WiFi" s'affiche.



④ Si le WiFi est éteint, faites-glisser l'interrupteur WiFi sur la position "OUI".

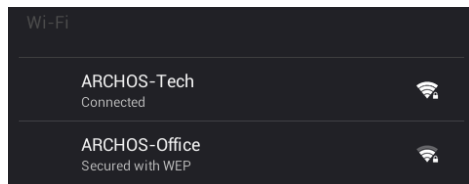



⑤ Une fois que le WiFi est activé, la tablette recherche des réseaux WiFi à portée. Sélectionnez le nom du réseau auquel vous voulez vous connecter. Les réseaux privés sont affichés avec un cadenas. Ils nécessitent un mot de passe.

## Connexion rapide

Vous pouvez vous connecter à votre réseau WiFi via le service WPS (WiFi Protected Setup).

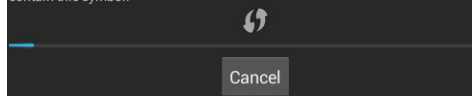
Press the WiFi Protected Setup button on your router. It may be called "WPS" or contain this symbol:



① Appuyez sur le bouton WPS  dans Paramètres > Sans fil et réseaux.

② Sur votre routeur Internet, appuyez le bouton WPS nommé WPS ou qui porte le symbole .

### ASTUCES :

- Lorsque vous saisissez un mot de passe, nous vous recommandons de cocher «Afficher mot de passe» afin de voir les caractères que vous saisissez. Pour obtenir le mot de passe ou les paramètres du réseau WiFi, contactez le fournisseur d'accès à Internet. Si votre WiFi est activé et que vous êtes à portée d'un réseau auquel vous vous êtes déjà connecté, votre tablette tente d'établir automatiquement une connexion.
- Pour maintenir votre connexion WiFi active lorsque la tablette est en veille, sélectionnez l'icône de Menu dans l'écran "WiFi", puis sélectionnez Options avancées > WiFi actif en veille > Toujours.

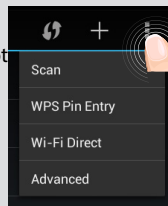

# L'interface Android™





- ① **Raccourcis d'applications Android™**  
> Sélectionnez une application pour l'ouvrir.
- ② **Raccourcis permanents d'applications Android™**
- ③ **"Retour"**
- ④ **"Accueil"**
- ⑤ **"Applications récentes"**
- ⑥ **icône Archos mapping tool**
- ⑦ **" Toutes les Applications"**  
> Sélectionnez pour afficher toutes les applications et les widgets installés sur votre ARCHOS. Vous retrouverez toutes vos applications téléchargées.
- ⑧ **Google™ Search**  
> Sélectionnez "Google" pour saisir votre recherche ou l'icône microphone pour l'énoncer.
- ⑨ **Barre de statuts**  
> Elle affiche les notifications et permet l'accès aux réglages rapides.



# L'interface Android™

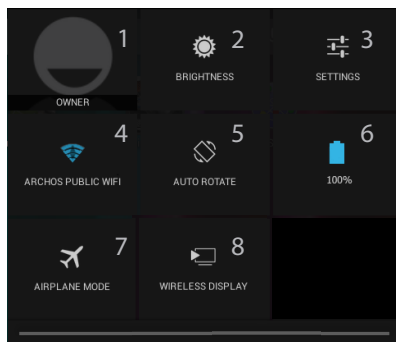

## 3:18 Les Réglages rapides

- 1 Affiche l'icône de l'utilisateur actuel<sup>(1)</sup>.
- 2 Pour ajuster la luminosité de l'écran.
- 3 Pour accéder à tous vos paramètres.
- 4 Pour activer/désactiver votre connexion WiFi.
- 5 Pour activer/désactiver l'orientation automatique de l'écran dès que vous tournez votre tablette.
- 6 Pourcentage de batterie restant
- 7 Pour activer/désactiver toutes les connexions sans fil. Par exemple, pour prendre l'avion.  
Pour permettre l'affichage sans fil<sup>(2)</sup>

<sup>(1)</sup>Cette option permet à différents utilisateurs d'une même tablette d'avoir chacun son propre espace personnalisable. Ajoutez des utilisateurs à partir de Paramètres > Appareil.

<sup>(2)</sup>Vous pouvez partager sur votre téléviseur HD des films, des vidéos de YouTube et tout autre média affiché sur votre tablette. Il faut au préalable connecter un adaptateur Wi-Di au port HDMI de votre téléviseur pour dupliquer facilement et rapidement ce qui est affiché sur votre tablette.

## Les Applications récentes

L'application affiche une liste de vignettes des applications utilisées récemment.

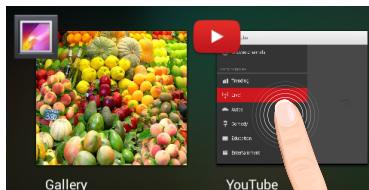

**Pour afficher une application**, sélectionnez-la.

**Pour afficher des informations**, maintenez appuyé.

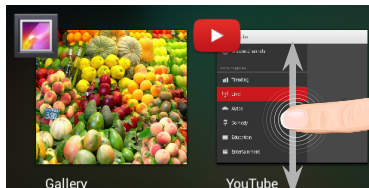

**Pour fermer une application**, faites-la glisser vers le haut ou vers le bas.

# L'ARCHOS mapping tool

L'ARCHOS mapping tool est une application installée sur votre ArcBook. Elle vous permet d'associer les boutons virtuels des jeux aux boutons physiques du ArcBook.

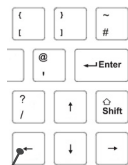

un bouton physique



un bouton de mapping

un bouton virtuel

## Astuce 1:

Plus de 100 configurations de jeux sont déjà intégrées. En outre, plusieurs jeux permettent l'utilisation automatique des boutons physiques sans aucun mapping.

## Astuce 2:

Dès que vous démarrez un jeu dont les boutons virtuels ont été déjà mappés, le mapping correspondant est sélectionné automatiquement.



## Ouvrir l'ARCHOS mapping tool

1. Sélectionnez un jeu.

Une fois sur l'écran de démarrage, les touches virtuelles s'affichent.

2. Sélectionnez l'icône ARCHOS mapping tool à partir de la barre système.



Icône de l'ARCHOS mapping tool

L'interface de l'application ARCHOS mapping tool s'affiche.

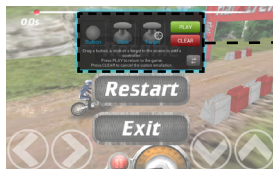

### Interface de l'ARCHOS mapping tool

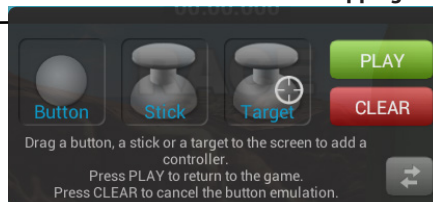

# L'ARCHOS mapping tool

## Placer un bouton de mapping

Sélectionnez un bouton de mapping et faites-le glisser sur le bouton virtuel souhaité.

Il existe trois types de boutons de mapping



Bouton

Il est utilisé pour les boutons directionnels ◀, ▶, ↘, ↙, ↗, ↖, les boutons X, Y, B, A et les boutons L1, R1, L2, R2, Start, Select.



Stick

Il est utilisé pour les joysticks directionnels analogiques



Cible

Il est utilisé pour les joysticks directionnels analogiques servant de pointeur de cible. Il est placé en général dans la partie centrale de l'écran sur les jeux de tir.

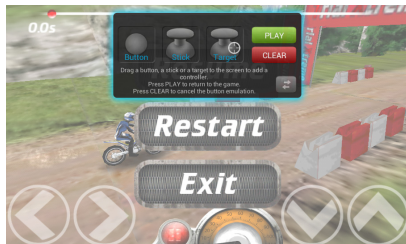



## Associer un bouton de mapping à un bouton physique

1. Lorsque vous placez un bouton de mapping sur un bouton virtuel, il faut sélectionner le bouton ou le stick analogique auquel vous voulez l'associer.

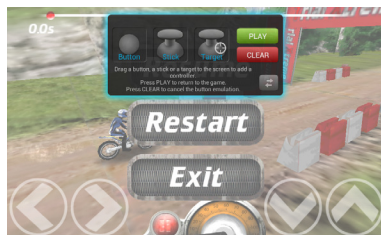

2. Dès qu'un bouton physique est associé au bouton de mapping, le nom du bouton physique est affiché sur le bouton de mapping.





# L'ARCHOS mapping tool

---

## Agrandir un bouton de mapping

Certains boutons virtuels sont plus grands que les boutons de mapping.

1. Changez la taille avec le joystick analogique droit.
2. Validez avec le bouton A.

Vous pouvez seulement agrandir les boutons de mapping Stick et Cible.

## Sauvegarder vos paramètres

Une fois que vous avez mappé les boutons virtuels d'un jeu, sélectionnez Jouer  pour valider. La configuration est sauvegardée et définie pour ce jeu.

L'interface ARCHOS mapping tool est fermée et vous pouvez jouer.

A chaque fois que vous démarrez le jeu, on vous informe que l'émulation des boutons virtuels est active. Chaque configuration est spécifique à un jeu.

Sélectionnez le message de notification afin d'afficher la configuration des boutons virtuels. Il est possible de la modifier ou de la supprimer.



## Questions & Réponses à propos de la configuration des touches

Vous avez placé un bouton de mapping sur un bouton virtuel mais aucune option ne s'affiche?

1. Appuyez sur le bouton de mapping.

Une boîte de dialogue s'affiche.

2. Sélectionnez l'icône  pour paramétrer le bouton de mapping.

Vous voulez supprimer un bouton de mapping défini?

1. Appuyez sur le bouton de mapping.

Une boîte de dialogue s'affiche.

2. Sélectionnez l'icône  pour supprimer le bouton de mapping.

Vous voulez supprimer la configuration des touches d'un jeu?

1. A partir de l'ARCHOS mapping tool, sélectionnez Effacer.

2. Sélectionnez OK pour confirmer.

### Afficher des options



### Supprimer une configuration

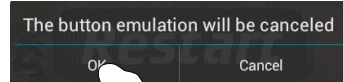
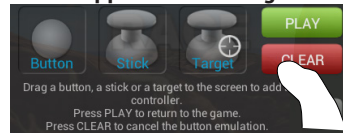



# Se familiariser avec Android™

## Utiliser le Pavé Tactile

Pour un appui court: appuyez sur le pavé tactile une fois.

Pour un appui long: appuyez sur le bouton du pavé tactile.

### L'écran d'accueil étendu :

**Avec le doigt :** naviguez entre les différents écrans d'accueil en faisant glisser votre doigt vers la gauche ou vers la droite.

**Avec le pavé tactile :** Maintenez le bouton du pavé tactile enfoncé tout en déplaçant le curseur avec le pavé tactile.

### Déplacer une icône de l'écran d'accueil :

Avec votre doigt : Maintenez votre doigt appuyé sur l'icône jusqu'à ce que s'affichent les lignes de positionnement, puis faites-la glisser vers l'emplacement souhaité, et relâchez.

Avec le pavé tactile : Sélectionnez l'icône avec le curseur et maintenez enfoncé le bouton du pavé tactile. Tout en maintenant le bouton enfoncé, utilisez le pavé tactile pour déplacer l'élément.

### Supprimer une icône de l'écran d'accueil :

**Avec le doigt :** Maintenez votre doigt appuyé sur l'icône, puis faites-la glisser vers le haut de l'écran, et déposez-la sur l'icône "Supprimer".

**Avec le pavé tactile :** Sélectionnez l'icône avec le curseur et maintenez enfoncé le bouton du pavé tactile. Tout en maintenant le bouton enfoncé, utilisez le pavé tactile pour déplacer l'élément vers le haut de l'écran, et déposez-le sur l'icône "Supprimer".

### Désinstaller une application :

**Avec le doigt :** à partir de l'écran "Toutes les applications", maintenez votre doigt appuyé sur l'icône, puis faites-la glisser vers le haut de l'écran et déposez-la sur l'icône "Désinstaller".





**Avec le pavé tactile :** à partir de l'écran "Toutes les applications", sélectionnez l'élément avec le curseur et maintenez enfoncé le bouton du pavé tactile. Tout en maintenant enfoncé le bouton, utilisez le pavé tactile pour déplacer l'élément vers le haut de l'écran et déposez-le sur l'icône "Désinstaller".

### **Créer des dossiers d'applications :**

A partir d'un écran d'accueil, déposez une icône sur une autre pour les rassembler.

### **Widgets :**

Sélectionnez l'icône "Toutes les applications". Sélectionnez "Widgets" en haut de l'écran. A partir de l'écran d'accueil des widgets, vous pouvez déplacer les widgets de la même façon que vous procédez avec les applications.

### **Changer le fond d'écran :**

**Avec le doigt :** Maintenez votre doigt appuyé sur un emplacement vide de l'écran, puis choisissez parmi la liste d'options.

**Avec le pavé tactile :** Sur un emplacement vide de l'écran d'accueil, faites un appui long sur le bouton du pavé tactile.

### **Verrouiller votre tablette :**

A partir du panneau des réglages rapides dans la barre de statuts, sélectionnez "Paramètres". Faites défiler l'écran vers le bas, puis sélectionnez "Sécurité". Sélectionnez "Verrouillage de l'écran". Sélectionnez le type de verrouillage que vous voulez utiliser. Une fois que vous avez sélectionné une option, un écran de verrouillage s'affiche chaque fois que votre écran est réactivé. Vous êtes alors invité à saisir le schéma, le code PIN ou tout autre code spécifié.

### **Lancer l'application ARCHOS Musique**

Faites un appui long sur le bouton de raccourci Play/Pause du clavier.



# Dépannage

---

## **Si votre appareil ne répond pas :**

Appuyez sur le bouton ON/OFF pendant 10 secondes ou utilisez le bouton Reset.

Appuyez sur le bouton reset en utilisant un objet pointu tel qu'un trombone.

## **Si votre appareil ne s'allume pas :**

1. Chargez votre appareil.

2. Appuyez sur le bouton ON/OFF pendant 10 secondes ou utilisez le bouton Reset.

Appuyez sur le bouton reset en utilisant un objet pointu tel qu'un trombone.

## **Si vous voulez prolonger l'autonomie de la batterie :**

Diminuez la luminosité de l'écran et désactivez les connexions sans fil si elles sont inutilisées.

## **Si votre appareil fonctionne au ralenti :**

Fermez les applications qui ne sont pas en cours d'utilisation.

## **Si votre réception WiFi est trop faible :**

Assurez-vous de ne pas être trop loin de la borne WiFi.

Mettez à jour le logiciel du produit: <http://www.archos.com/support>.

Réinitialisez vos paramètres de connexion WiFi.

Contactez le fournisseur d'accès.

## **Si vous voulez restaurer les valeurs d'usine (mot de passe oublié? effacer tous vos réglages?) :**

1. Insérez un objet pointu dans le bouton de restauration totale.

2. Maintenez le bouton appuyé et connectez le câble d'alimentation au produit et à une prise.

Le système de restauration d'Android est affiché.





# Inhaltsverzeichnis

Beschreibung des Packungsinhalts.....	42
Erste Schritte.....	43
Beschreibung des Geräts.....	44
WiFi (WLAN)-Verbindung.....	46
Die Android™ Benutzeroberfläche.....	48
ARCHOS Mapping-Tool.....	52
Android™ kennenlernen.....	58
Fehlersuche.....	60

Weitere Informationen finden Sie unter den FAQs unter [www.archos.com](http://www.archos.com). Bitte lesen Sie diese Informationen sorgfältig, bevor Sie die Rückgabe eines Produkts erwägen. Möglicherweise läßt sich Ihr Problem leicht lösen. Da unsere Produkte kontinuierlich aktualisiert und weiterentwickelt werden, kann die Software Ihres Geräts in Erscheinung und Funktionalität geringfügige Abweichungen zu den Darstellungen in dieser Kurzbedienungsanleitung aufweisen.

# Beschreibung des Packungsinhalts

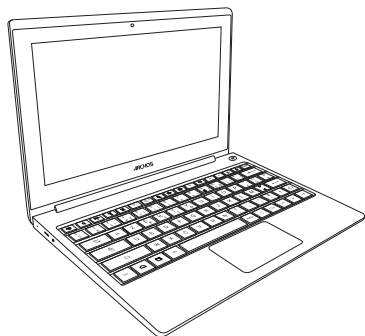

ARCHOS ArcBOOK



Benutzerhandbuch



Garantie, Impressum  
und Sicherheitshinweise



USB Kabel

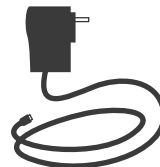

Ladegerät

# Erste Schritte

## Aufladen des Akkus

1. Verbinden Sie das mitgelieferte Stromkabel mit dem ARCHOS und mit einer Steckdose. Daraufhin startet den Ladevorgang.

Während des Ladens der Batterie leuchtet die Ladeanzeige rot.

Es wird blau leuchten, wenn der Akku vollständig geladen ist.

**Wenn das Gerät  
ausgeschaltet ist**

Drücken Sie den AN/AUS Knopf um es anzuschalten.

**Wenn das Gerät  
angeschaltet ist**

- Drücken Sie den AN/AUS Knopf nur kurz um es in den Schlafmodus zu versetzen.
- Drücken Sie den AN/AUS Knopf lange um die Optionen anzuzeigen und wählen Sie die Option es auszuschalten

### TIPP:

Sie können den ARCHOS auch während des Ladens verwenden. Laden Sie Ihr Gerät vor der ersten Nutzung einmal vollständig auf. Verwenden Sie nur das mitgelieferte Netzgerät.

Um unseren Service voll nutzen zu können, empfehlen wir Ihnen, Ihr Produkt zu registrieren.

Für die Registrierung mittels Computer gehen Sie zu [www.archos.com/register](http://www.archos.com/register).



# Beschreibung des ARCHOS

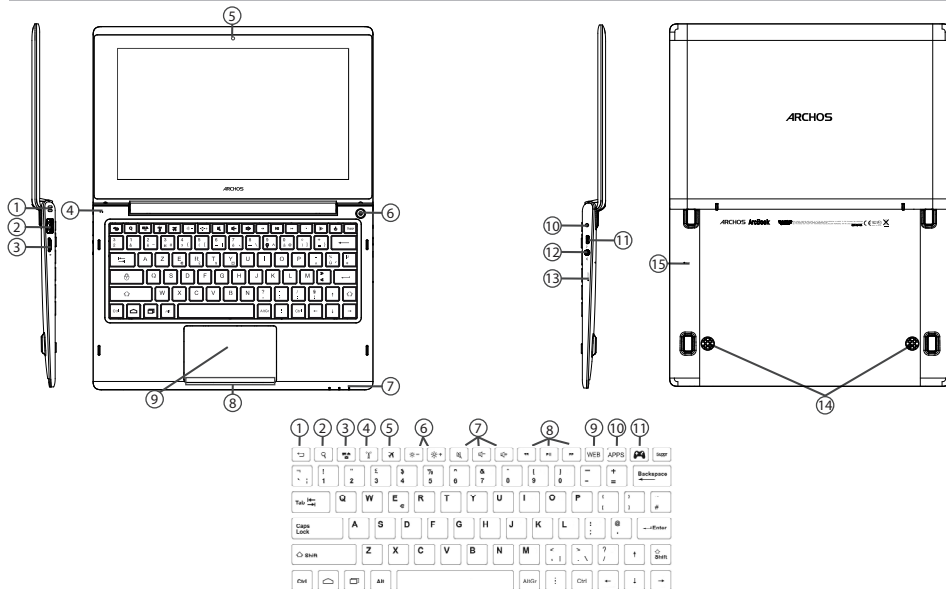



## Geräteanschlüsse

- |                         |                     |                       |
|-------------------------|---------------------|-----------------------|
| ① Sicherungsloch        | ⑥ AN/AUS Knopf      | ⑪ Micro-USB Anschluss |
| ② USB Anschluss         | ⑦ Ladeanzeige       | ⑫ Kopfhörerbuchse     |
| ③ Micro-SD Card Schlitz | ⑧ Touch Panel Taste | ⑬ Rückstelltaste      |
| ④ Mikrophon             | ⑨ Touch Panel       | ⑭ Lautsprecher        |
| ⑤ Webcam                | ⑩ Netzanschluss     | ⑮ Reset Taste         |

## Tastatur Shortcut-Taste

- |                      |                 |        |
|----------------------|-----------------|--------|
| ① Zurück             | ⑤ Flugzeugmodus | ⑨ WEB  |
| ② Suchen             | ⑥ Helligkeit    | ⑩ APPS |
| ③ Benachrichtigungen | ⑦ Lautstärke    |        |
| ④ WiFi               | ⑧ ARCHOS Music  |        |

# WiFi (WLAN) Verbindung

ACHTUNG: Stellen Sie sicher, dass Sie sich innerhalb einer WiFi(WLAN)-Zone aufhalten.



① Berühren und halten Sie die Symbole für Uhrzeit und Batterie, um die Statusleiste freizulegen. Es wird eine blaue Linie angezeigt.



② Ziehen Sie die blaue Linie nach unten, um das Status-Dashboard anzuzeigen.



③ Tippen Sie auf "WiFi off [WLAN aus]" im Status-Dashboard. Die WLAN-Seite wird jetzt angezeigt.

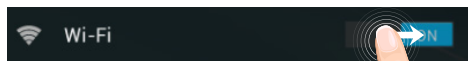

④ Wenn "WLAN" deaktiviert ist, schieben Sie den WLAN-Schalter in die Position "EIN".

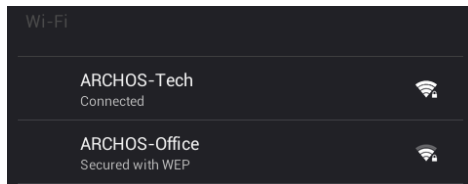

⑤ Sobald "WLAN" eingeschaltet ist, sucht der ARCHOS nach Netzwerken in Reichweite. Berühren Sie den Namen des Netzwerks, mit dem Sie verbunden werden möchten.

Gesicherte Netzwerke werden mit einem Schloss-Symbol angezeigt und erfordern die Eingabe eines Passworts.



## Schnellverbindung

Verbinden Sie mit Ihrem WLAN-Netzwerk über das WiFi Protected Setup.

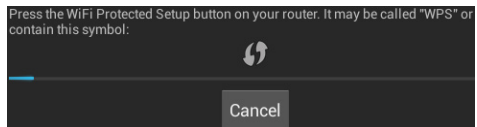

① Drücken Sie die Taste WiFi Protected Setup  unter Settings > Wireless & networks

② [Einstellungen > Drahtlos und Netzwerke]. Drücken Sie im Internet-Router die Taste WiFi Protected Setup, genannt WPS oder die Taste mit dem Symbol .

### TIPPS:

- Bei der Eingabe eines WLAN-Passworts empfehlen wir die Auswahl von "Show password [Passwort anzeigen], damit die eingegebenen Zeichen sichtbar sind. Das korrekte WLAN-Passwort (oder die Einstellungen) für das Netzwerk erhalten Sie vom Netzanbieter Ihres WLANs. Ist Ihr WLAN eingeschaltet und Sie befinden sich im Bereich eines Netzwerks, mit dem Sie zuvor schon einmal verbunden waren, wird Ihr ARCHOS automatisch mit diesem Netzwerk Verbindung aufnehmen.
- Um die WLAN-Verbindung zu halten, während sich das Gerät im Standby-Modus befindet, wählen Sie das Menüsymbol auf der Seite "WLAN". Wählen Sie dann Advanced > Keep WiFi on during sleep > Always [Erweitert > WLAN Standby-Richtlinie > Immer].

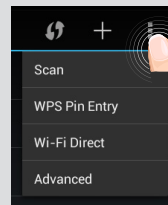

# Die Android™ Benutzeroberfläche







- ① **Android™ Apps**  
> Die Aktivierung einer App erfolgt durch Berühren.
- ② **Permanenten Android™ Apps-Verknüpfungen**
- ③ **“Zurück”**
- ④ **“Startbildschirm”**
- ⑤ **“Letzte Apps”**
- ⑥ **ARCHOS Mapping-Tool**
- ⑦ **“ Alle Apps”**  
> Berühren Sie dieses Symbol, um alle auf Ihrem ARCHOS installierten Apps und Widgets anzuzeigen. Alle heruntergeladenen Anwendungen befinden sich hier.
- ⑧ **Google™ Suche**  
> Suchbegriff eintippen oder Spracheingabe verwenden.
- ⑨ **Statusleiste**  
> Auf der Statusleiste werden Benachrichtigungen und die Systemsymbole angezeigt.

# Die Android™ Benutzeroberfläche

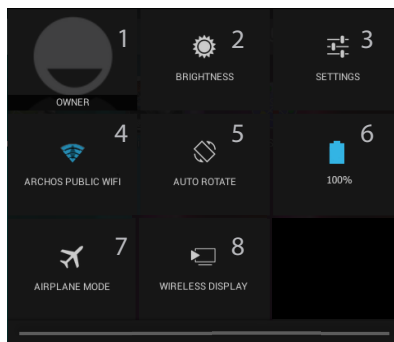

## 3:18 Schnelleinstellungen

- 1 Aktueller Benutzer<sup>(1)</sup>
- 2 Einstellung der Bildschirmhelligkeit.
- 3 Zugriff auf alle Einstellungen.
- 4 Ein- und Ausschalten der WLAN-Verbindung.
- 5 Ermöglicht die Aktivierung und Deaktivierung der automatischen Display-Drehung.
- 6 Akkurestlaufzeit in Prozent
- 7 Beendet alle WLAN-Verbindungen, nützlich für Flugreisen.
- 8 Wireless Display aktivieren<sup>(2)</sup>

<sup>(1)</sup>Mit dem neuen Multi-User-Support für Tablets besitzt jeder Benutzer seinen eigenen separaten und anpassbaren Bereich auf einem einzelnen Gerät. Benutzer können unter Settings > Device [Einstellungen > Gerät] hinzugefügt werden.

<sup>(2)</sup>Sie können Filme, YouTube-Videos und alles, was sich auf Ihrem Bildschirm befindet, auf einem HDTV teilen. Sie müssen ein Wireless Display-Adapter an einen HDMI-fähigen Fernseher anschließen, um so schnell und einfach den Inhalt Ihres Bildschirms wiederzugeben.



## Letzte Apps

Öffnet eine Liste mit Mini-Abbildungen der kürzlich verwendeten Apps:



**Tippen:** öffnen einer Anwendung.

**Länger drücken:** Anzeige von Optionen



**Nach oben oder unten wischen:** Eine Anwendung schließen.

# ARCHOS Mapping-Tool

Das ARCHOS Mapping-Tool ist eine auf Ihrem ArcBook installierte Anwendung. Es ermöglicht Ihnen die Verbindung der virtuellen Steuerung der Spiele mit der physischen Steuerung des ArcBook mittels Mapping-Steuerung.

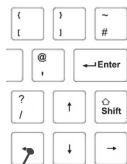

eine physische Steuerung

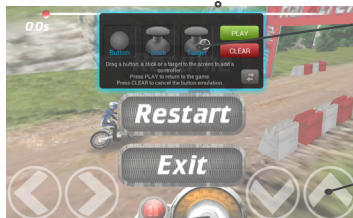

eine Mapping-Steuerung

eine virtuelle Steuerung

## Tipp 1:

Innerhalb des ARCHOS-Mapping-Tools befinden sich bereits Mapping-Profilen für über 100 Spiele. Außerdem funktionieren viele Spiele automatisch mit physischen Tasten.

## Tipp 2:

Immer wenn Sie ein Spiel starten, dessen virtuelle Steuerung gemappt ist, wird das richtige Mapping-Profil automatisch ausgewählt.



## Starte ARCHOS Mapping-Tool

1. Ein Spiel starten.

Sobald Sie den Startbildschirm erreichen, wird die virtuelle Steuerung angezeigt.

2. Wählen Sie in der Symbolleiste das ARCHOS Mapping-Tool-Symbol.



— ARCHOS Mapping-Tool-Symbol

Das Mapping-Overlay wird mit der Mapping-Tool-Benutzeroberfläche angezeigt.



### ARCHOS Mapping-Tool-Benutzeroberfläche

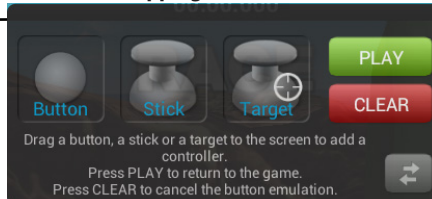

# ARCHOS Mapping-Tool

## Positionierung einer Mapping-Steuerung

Halten und ziehen Sie einen Typ von Mapping-Steuerung in die gewünschte virtuelle Taste.

Es gibt drei verschiedene Arten von Mapping-Steuerung



Taste

Ist für das Steuerkreuz, die X-, Y-, B-, A-Tasten und die Tasten L1, R1, L2, R2, Start, Select.



Stick

Ist für die analogen Richtungs-Sticks.



Ziel

Ist für die Analog-Stick-Zielauswahl. Normalerweise erfolgt eine Platzierung im zentralen Bereich des Bildschirms bei Schießspielen.

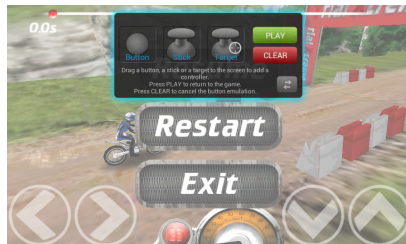



## Verbindung einer Mapping-Steuerung mit einer physischen Steuerung

1. Wird eine Mapping-Steuerung auf einer virtuellen Steuerung platziert, müssen Sie die gewünschte physische Steuerung auswählen, der Sie sie zuweisen möchten.

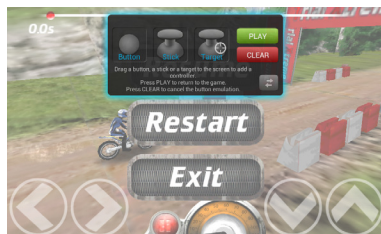

2. Nachdem eine physische Steuerung der Mapping-Steuerung zugewiesen wurde, wird der Name der physischen Steuerung auf der Mapping-Steuerung angezeigt.





# ARCHOS Mapping-Tool

---

## Vergrößerung einer Mapping-Steuerung

Manche der virtuellen Steuerungen sind größer als die Mapping-Steuerungen.

1. Ändern Sie die Größe mit rechten Analog-Stick.
2. Drücken Sie die Taste A zu bestätigen.

Sie können nur die Mapping-Steuerungen Stick und Ziel vergrößern.

## Speicherung Ihrer Parameter

Sobald Sie die virtuelle Steuerung des Spiels gemappt haben, wählen Sie "Play" , um zu bestätigen. Das Profil ist gespeichert und wurde diesem Spiel zugewiesen.

Das Mapping-Overlay verschwindet und Sie können spielen.

Wann auch immer Sie das Spiel starten, werden Sie über Folgendes informiert: Die Emulation der virtuellen Tasten wird gestartet. Jedes Mapping gehört spezifisch zu einem Spiel.

Drücken Sie auf die Benachrichtigung, um das Mapping-Profil des Spiels anzuzeigen. Sie können es bearbeiten oder löschen.





## F&A über das Mapping

Sie haben eine Mapping-Steuerung auf einer virtuellen Steuerung platziert, aber es ist keine Option verfügbar?

1. Drücken Sie auf die Mapping-Steuerung.

Ein Menüfeld wird angezeigt.

2. Wählen Sie zur Einrichtung der Mapping-Steuerung das Symbol .

Sie möchten eine von Ihnen festgelegte Mapping-Steuerung entfernen?

1. Drücken Sie auf die Mapping-Steuerung.

Ein Menüfeld wird angezeigt.

2. Wählen Sie zur Entfernung der Mapping-Steuerung das Symbol .

Sie möchten ein für ein Spiel festgelegtes Mapping-Profil entfernen?

1. In der Schnittstelle des Spiels, wählen Sie die „Mapping-Tool“-Symbol.

2. Wählen Sie im ARCHOS Mapping-Tool "Löschen".

3. Wählen Sie "OK", um zu bestätigen.

### Anzeigeoptionen

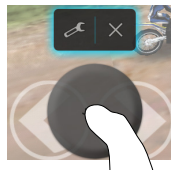

### Entfernung eines Mapping-Profiles

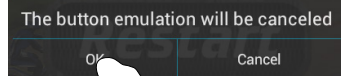
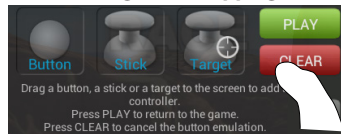



# Android™ kennenlernen

## **Das Touch Panel benutzen:**

Um nur kurz zu drücken: Berühren Sie den Touch Panel ein mal kurz.

Um lange zu drücken: Halten Sie die Touch Panel Taste gedrückt

## **Der erweiterte Startbildschirm:**

Wechseln Sie durch Wischen nach links und rechts zwischen verschiedenen «Home»-Bildschirmen.

Touch Panel: Halten Sie die Touch Panel Taste gedrückt, während Sie den Cursor mit dem Touch Panel bewegen

## **Ein Element vom Startbildschirm verschieben:**

Zum Verschieben eines Elements vom Startbildschirm den Finger darauf legen und so lange halten, bis die Rasterlinien zur Positionierung erscheinen. Dann an die gewünschte Stelle schieben und loslassen.

Touch Panel: Wählen Sie das Element mit dem Cursor aus und halten Sie die Touch Panel Taste gedrückt. Während Sie die Touch Panel Taste gedrückt halten, bedienen Sie das Touch Panel um das Element zu bewegen.

## **Ein Element vom Startbildschirm entfernen:**

Den Finger auf das Element legen und halten. Den Finger auf dem Bildschirm nach oben bewegen und über dem "Entfernen"-Symbol loslassen.

Touch Panel: Wählen Sie das Element mit dem Cursor aus und halten Sie die Touch Panel Taste gedrückt. Während Sie die Touch Panel Taste gedrückt halten, bedienen Sie das Touch Panel um es nach oben im Bildschirm zu schieben und setzen Sie es über dem Entfernen Symbol ab X.

## **Ein Element deinstallieren:**

Auf den «Alle Apps»-Bildschirmen das betreffende Element berühren und halten. Den Finger im Bildschirm nach oben bewegen und über dem "Deinstallieren"-Papierkorb loslassen.





Touch Panel: Wählen Sie auf dem „All Apps“ Bildschirm das Element mit dem Cursor aus und halten Sie die Touch Panel Taste gedrückt. Während Sie die Touch Panel Taste gedrückt halten, bedienen Sie das Touch Panel um es nach oben im Bildschirm zu schieben und setzen Sie es über dem Papierkorb Symbol ab.

### **Anwendungsordner erstellen:**

Ziehen Sie auf einem Startbildschirm ein Anwendungssymbol über ein anderes. Die beiden Symbole werden kombiniert.

### **Widgets:**

Berühren Sie das "Alle Apps"-Symbol auf dem Startbildschirm. Berühren Sie "Widgets" oben auf dem Bildschirm. Auf dem "Widgets"-Hauptbildschirm können Sie Widgets genau wie Anwendungssymbole auch verschieben.

### **Hintergrundbild ändern:**

Den Finger auf eine freie Stelle des Bildschirms legen und dann aus der Liste auswählen. Touch Panel: Halten Sie die Touch Panel Taste an einer leeren Stelle auf der HomeScreen gedrückt.

### **Touchscreen sperren:**

Berühren Sie Einstellungen auf dem Schnelleinstellungen-Dashboard in der Statusleiste. Scrollen Sie nach unten und berühren Sie "Sicherheit". Berühren Sie Bildschirmsperrung. Berühren Sie die gewünschte Art der Sperrung. Nach erfolgter Sperrung wird ein Sperrbildschirm angezeigt, sobald der Bildschirm aktiviert wird. Auf diesem ist ein Muster, eine PIN oder ein anderer festgelegter Schlüssel einzugeben.

### **ARCHOS Music App öffnen:**

Drücken Sie die Play/Pause Shortcut-Taste auf der Tastatur lange.



# Fehlersuche

## **Das Gerät reagiert nicht mehr:**

Halten Sie die EIN/AUS-Taste 10 Sekunden lang gedrückt oder verwenden Sie den Hardware-Reset. Um den Hardware-Reset auszuführen, führen Sie einen spitzen Gegenstand, wie etwa eine Büroklammer, in die dafür vorgesehene Öffnung des Gehäuses und drücken Sie so die Büroklammer-Reset-Taste.

## **Wenn sich das Gerät nicht wieder einschaltet:**

1. Laden Sie das Gerät auf.
2. Halten Sie die EIN/AUS-Taste 10 Sekunden lang gedrückt oder verwenden Sie den Hardware-Reset – wie zuvor beschrieben.

## **Akkulaufzeit verlängern:**

Verringern Sie die Bildschirmhelligkeit und schalten Sie die WiFi(WLAN)-Verbindungen aus, wenn diese nicht verwendet werden.

## **Das Gerät ist zu langsam:**

Schließen Sie alle Anwendungen, die nicht verwendet werden.

## **WiFi(WLAN)-Empfang ist zu schwach:**

Stellen Sie sicher, dass Sie sich in Reichweite eines WiFi(WLAN)-Hotspots befinden. Aktualisieren Sie die Firmware des Gerätes: <http://www.archos.com/support>. Setzen Sie die WiFi-Verbindung zurück. Kontaktieren Sie Ihren WiFi(WLAN)-Provider.

## **Wenn das Produkt zurückgesetzt werden soll (Passwort vergessen? Löschen Ihrer Einstellungen?):**

1. Legen Sie eine Büroklammer in der Rücksteltaste.
2. Halten Sie die Büroklammer in der Rücksteltaste und verbinden Sie das Stromkabel mit dem ARCHOS.



# Índice

Contenido de la caja.....	62
Procedimientos iniciales.....	63
Descripción del ARCHOS.....	64
Conexión a una red WiFi.....	66
La interfaz Android™.....	68
ARCHOS mapping tool.....	72
Para familiarizarse con Android™.....	78
Solución de problemas.....	80

Para obtener más información, consulte la sección de preguntas frecuentes en la dirección [www.archos.com](http://www.archos.com). Asegúrese de leerlos antes de considerar devolver el producto. Puede haber una solución fácil a su problema. Tenga en cuenta que como estamos actualizando y mejorando constantemente nuestros productos, el software de su dispositivo puede variar ligeramente con respecto a lo descrito en esta Guía Rápida.

# Contenido de la caja

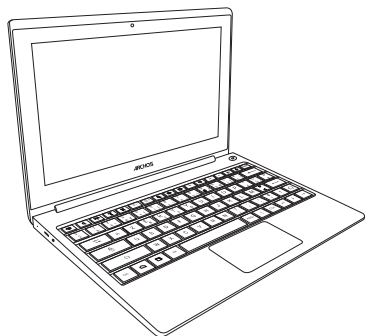

ARCHOS ArcBOOK



Guía de usuario



Avisos de garantía,  
legales y de seguridad

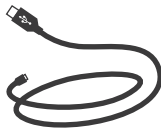

Cable USB

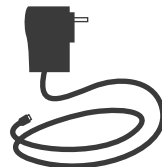

Cargador

# Procedimientos iniciales

## Cargado de la batería

Para cargar el dispositivo, conecte el cable de alimentación al puerto micro-USB.

El dispositivo ARCHOS iniciará la carga.

El indicador de carga se ilumina en rojo mientras se carga la batería.

Pasará a azul cuando la batería esté totalmente cargada.

<b>Con el dispositivo apagado</b>	Pulse el botón encender/apagar para encenderlo.
<b>Con el dispositivo encendido</b>	<ul style="list-style-type: none"><li>- Pulse brevemente el botón encender/apagar para ponerlo en modo suspensión</li><li>- Mantenga pulsado el botón encender/apagar para mostrar las opciones y seleccionar Apagar</li></ul>

### CONSEJOS:

Puede utilizar el ARCHOS mientras se carga. Deje cargar completamente el dispositivo la primera vez que lo utilice. Utilice únicamente el cargador suministrado.

Para recibir una asistencia más completa, registre su producto. Con un ordenador, vaya a [www.archos.com/register](http://www.archos.com/register).



# Descripción del ARCHOS

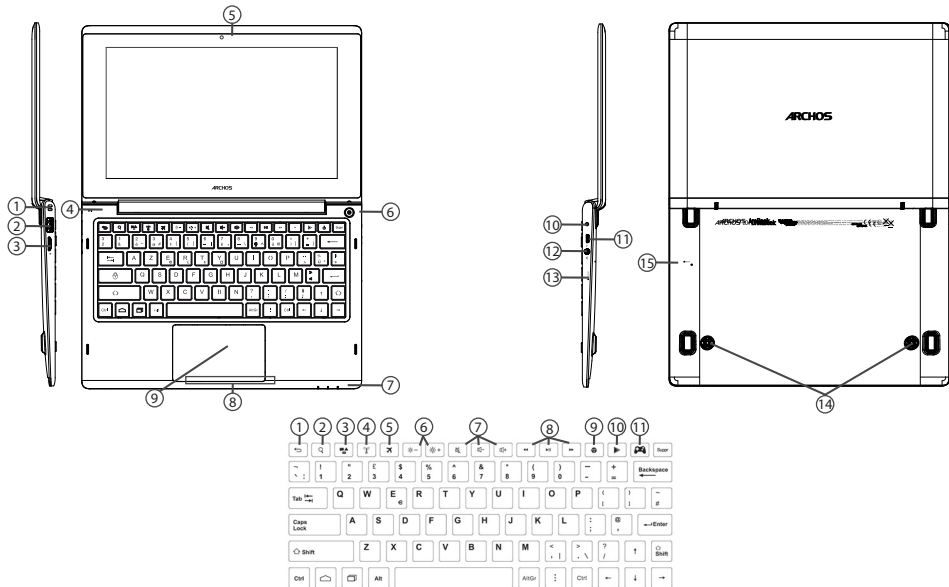





## Conectores del dispositivo

- |                                 |                                  |                       |
|---------------------------------|----------------------------------|-----------------------|
| ① Orificio de bloqueo           | ⑥ Botón Encender/apagar          | ⑪ Puerto micro USB    |
| ② Puerto USB                    | ⑦ Indicador de carga             | ⑫ Toma de auriculares |
| ③ Ranura para tarjetas micro SD | ⑧ Botón de la alfombrilla táctil | ⑬ Botón Restablecer   |
| ④ Micrófono                     | ⑨ Alfombrilla táctil             | ⑭ Altavoces           |
| ⑤ Webcam                        | ⑩ Conector de alimentación       | ⑮ Botón Reset         |

## Atajos del teclado

- |                      |                        |              |
|----------------------|------------------------|--------------|
| ① Botón Atrás        | ⑤ Botón Modo avión     | ⑨ Botón WEB  |
| ② Botón Buscar       | ⑥ Botones Brillo       | ⑩ Botón APPS |
| ③ Botón Notificación | ⑦ Botones de Volumen   |              |
| ④ Botón WiFi         | ⑧ Botones ARCHOS Music |              |

# Conexión WiFi

ADVERTENCIA: Asegúrese de que se encuentra en una zona WiFi.



① Mantenga pulsados los iconos de reloj y batería para mostrar la barra de estado. Aparecerá una franja azul.



② Arrastre la franja azul hacia abajo para mostrar el panel de estado.



③ Pulse "WiFi off [Desactivar WiFi]" en el panel de estado. Aparecerá la página WiFi.

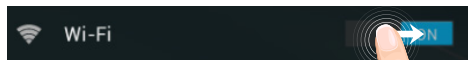

④ Si el sistema WiFi está desactivado, deslice el interruptor WiFi para ajustarlo en la posición "ON".

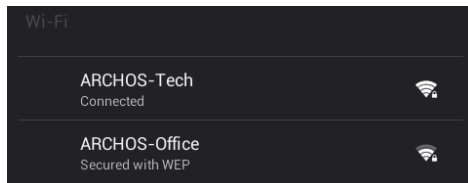



⑤ Una vez activado el sistema WiFi, el ARCHOS buscará redes WiFi que se encuentren dentro de su alcance. Toque el nombre de la red a la que desee conectarse. Las redes privadas se muestran con un icono de candado y será preciso que introduzca su contraseña.

## Conexión rápida

Puede conectarse a su red WiFi a través de una configuración protegida WiFi.

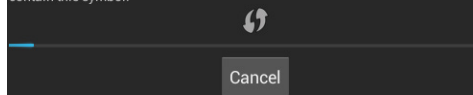
Press the WiFi Protected Setup button on your router. It may be called "WPS" or contain this symbol:



① Pulse el botón de Configuración protegida WiFi  en Ajustes > Conexiones

② inalámbricas y redes.

En su router de Internet, pulse el botón de Configuración protegida WiFi llamado WPS o que contiene el símbolo .

### CONSEJOS:

- Al introducir la contraseña WiFi, le recomendamos que seleccione "Mostrar contraseña" para poder ver lo que escribe. Póngase en contacto con su proveedor de acceso WiFi para conocer la contraseña (o los ajustes) WiFi de la red. Si la WiFi está encendida y usted se encuentra dentro del área de cobertura de la red, a la que ya se ha conectado con anterioridad, el ARCHOS intentará conectarse automáticamente a ella.
- Para mantener la conexión WiFi activada con el dispositivo en reposo, seleccione el icono de menú en la página "WiFi". Luego, seleccione Avanzado > Mantener WiFi activo durante el periodo de reposo > Siempre.

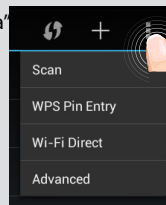

# El Interfaz Android™





- ① **Aplicaciones Android™**  
> Toque para iniciar una aplicación.
- ② **Acceso directo permanente a aplicaciones Android™**
- ③ **"Volver"**
- ④ **"Inicio"**
- ⑤ **"Aplicaciones recientes"**
- ⑥ **ARCHOS mapping tool**
- ⑦ **"Todas las aplicaciones"**  
> Toque este icono para mostrar todas las aplicaciones y widgets instalados en el ARCHOS. Todas las aplicaciones descargadas se encuentran aquí.
- ⑧ **Google™ Search**  
> Toque para búsqueda de texto o busque por voz .
- ⑨ **Barra de estado**  
> Muestra notificaciones y ajustes rápidos.

# El Interfaz Android™

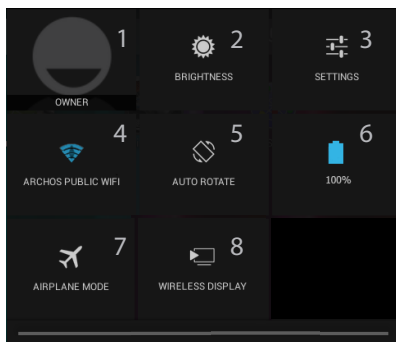

## 3:18 Los ajustes rápidos

- 1 Usuario actual<sup>(1)</sup>
- 2 Para ajustar el brillo de la pantalla.
- 3 Para acceder a todos los ajustes.
- 4 Para activar/desactivar la conexión WiFi.
- 5 Para activar/desactivar la orientación automática de la pantalla al girar el ARCHOS.
- 6 Porcentaje de batería restante
- 7 Para activar/desactivar todas las conexiones inalámbricas, especialmente al volar.
- 8 Para habilitar la visualización inalámbrica<sup>(2)</sup>

<sup>(1)</sup>El nuevo soporte multiusuario para tabletas permite que distintos usuarios tengan sus propios espacios personalizables e independientes en un único dispositivo. Añada usuarios en Settings > Device [Ajustes > Dispositivo].

<sup>(2)</sup>Puede compartir películas, vídeos de YouTube y cualquier cosa que aparezca en pantalla en un televisor HD. Deberá conectar un adaptador de pantalla inalámbrico a su televisor habilitado HDMI para reflejar lo que aparece en pantalla de forma rápida y sencilla.

## Aplicaciones recientes

Abre una lista de imágenes en miniatura de las aplicaciones con las que haya trabajado recientemente:



**Tocar:** para abrir una aplicación.

**Mantener pulsado:** para mostrar opciones

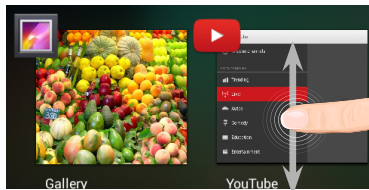

**Mover el dedo arriba o abajo:** para cerrar una aplicación.

# ARCHOS mapping tool

ARCHOS mapping tool es una aplicación instalada en el ArcBook que permite enlazar los controles virtuales de los juegos con los controles físicos del dispositivo ArcBook mediante el establecimiento de correspondencias entre ellos.



## Consejo 1:

La aplicación ARCHOS mapping tool viene ya con perfiles de asignación de botones para más de 100 juegos. Además, muchos de los juegos funcionan automáticamente con los botones físicos.

## Consejo 2:

Al lanzar un juego cuyos controles virtuales estén ya mapeados, se seleccionará automáticamente el perfil de asignación correcto.





## Introducción a ARCHOS mapping tool

1. Abra un juego.

Al llegar a la pantalla de inicio aparecerán los controles virtuales.

2. Seleccione el icono ARCHOS mapping tool en la barra de sistema.



icono de ARCHOS mapping tool

Junto con la interfaz de la aplicación, aparecerá superpuesta la representación de los botones.

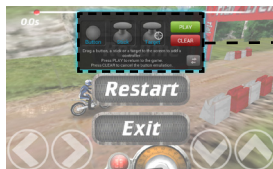

### interfaz de ARCHOS mapping tool

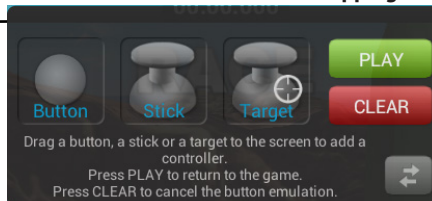

# ARCHOS mapping tool

## Colocación de los controles mapeados

Pulse y arrastre uno de los controles mapeados al botón virtual deseado.

Existen tres tipos de controles mapeados



Botón

Representa la cruzeta direccional ◀, ▶, ▼, ▲, los botones X, Y, B, A, y los botones L1, R1, L2, R2, Start, Select.



Joystick

Representa los joysticks direccionales analógicos.



Diana

Se utiliza para apuntar mediante joysticks analógicos. Aparece normalmente en el área central de la pantalla en los juegos de disparos.

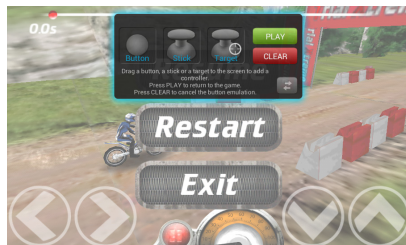

## Establecer una correspondencia entre un control mapeado y un control físico

1. Al colocar un control mapeado sobre un control virtual, se le pedirá que seleccione el control físico con el que lo quiere asociar.

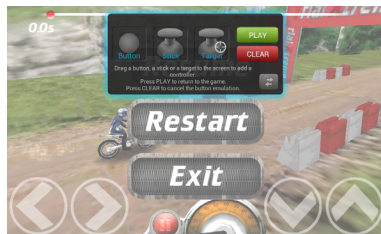

2. Una vez asociado el control físico con el control mapeado, el nombre del control físico aparecerá en el control mapeado.





# ARCHOS mapping tool

## Ampliación de un control mapeado

Algunos controles virtuales son más grandes que los controles mapeados.

1. Cambiar el tamaño con el stick analógico derecho.
2. Presione el botón A para confirmar.

Sólo se pueden ampliar los controles Joystick y Diana.

## Guardar los parámetros

Una vez asignados los controles virtuales del juego, seleccione "Play"  para confirmar su elección. El perfil se guardará y se asociará a ese juego.

La representación superpuesta de botones desaparecerá de la pantalla y podrá empezar el juego. Cada vez que se inicia el juego, se le dice que la emulación de los botones virtuales está activo. A cada juego le corresponde una asignación de botones específica.

Pulse la notificación para visualizar el perfil de mapeado del juego. Este perfil se puede modificar o borrar.



## Preguntas y respuestas sobre la asignación de botones

¿Ha colocado un control mapeado sobre un control virtual pero no hay ninguna opción disponible?

1. Pulsar el control mapeado.
2. Seleccione el icono  para configurar el control mapeado.

¿Desea eliminar un control mapeado creado por usted?

1. Pulsar el control mapeado.
2. Seleccione el icono  para borrar el control mapeado.

¿Desea eliminar el perfil de asignación de botones de un determinado juego?

1. En la interfaz del juego, seleccione el icono "mapping tool".
2. En la aplicación ARCHOS mapping tool, seleccione "Clear".
3. Pulse "OK" para confirmar.

## Opciones de visualización

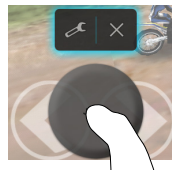

## Eliminación de un perfil de mapeado

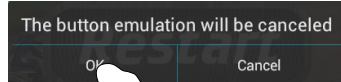
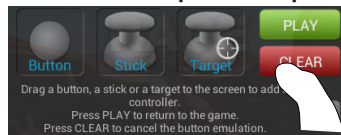



# Para familiarizarse con Android™

## **Utilización de la alfombrilla táctil:**

Para una pulsación corta: toque una vez la alfombrilla táctil.

Para una pulsación larga: mantenga pulsado el botón de la alfombrilla táctil.

## **La pantalla de inicio ampliada:**

Desplácese entre distintos paneles de la pantalla de inicio deslizando el dedo a la izquierda y la derecha.

**Alfombrilla táctil:** Mantenga pulsado el botón de la alfombrilla táctil mientras mueve el cursor con la alfombrilla táctil.

## **Desplazamiento de un elemento de la pantalla de inicio:**

Mantenga el dedo sobre él hasta que aparezcan líneas de cuadrícula de posición; a continuación, deslícelo hasta la ubicación deseada y suelte el dedo.

**Alfombrilla táctil:** Seleccione un elemento con el cursor y mantenga pulsado el botón de la alfombrilla táctil. Mientras tiene pulsado el botón de la alfombrilla táctil, use la alfombrilla táctil para mover el elemento.

## **Eliminación de un elemento de la pantalla de inicio:**

Mantenga el dedo sobre él, deslice el dedo hacia la parte superior de la pantalla y déjelo caer sobre el icono "Eliminar X".

**Alfombrilla táctil:** Seleccione un elemento con el cursor y mantenga pulsado el botón de la alfombrilla táctil. Mientras tiene pulsado el botón de la alfombrilla táctil, utilice esta última para moverlo hacia la parte superior de la pantalla y soltarlo en el icono de eliminación X.

## **Desinstalación de un elemento:**

En las pantallas "Todas las aplicaciones", mantenga el dedo sobre él, deslice el dedo hacia la parte superior de la pantalla y déjelo caer sobre la papelera "Desinstalar".





**Alfombrilla táctil:** En las pantallas de Aplicaciones, seleccione un elemento con el cursor y mantenga pulsado el botón de la alfombrilla táctil. Mientras tiene pulsado el botón de la alfombrilla táctil, utilice esta última para moverlo hacia la parte superior de la pantalla y soltarlo en el icono de papelera.

**Creación de carpetas de aplicaciones:**

Deje caer un icono de aplicación sobre otro en una pantalla de inicio y los dos iconos se combinarán.

**Widgets:**

Toque el icono odas las aplicaciones en la pantalla de inicio. Toque "Widgets" en la parte superior de la pantalla. En la pantalla Widgets principal, puede desplazarse de un widget a otro de la misma manera que lo hace para los iconos de aplicaciones.

**Cambio del fondo:**

Mantenga el dedo en la pantalla en una ubicación vacía y, a continuación, elija en la lista.

**Alfombrilla táctil:** Mantenga pulsado el botón de la alfombrilla táctil en un espacio vacío de la pantalla de inicio.

**Bloqueo de la pantalla táctil:**

En el escritorio digital de ajustes rápidos de la barra de estado, toque "Ajustes". Desplácese hacia abajo y toque "Seguridad" > "Bloqueo de la pantalla". Toque el tipo de bloqueo que desee utilizar. Tras definir aquí un bloqueo, aparecerá una pantalla de bloqueo cuando se active la pantalla, solicitando el patrón, PIN u otra clave especificada.

**Apertura de la aplicación ARCHOS Music:**

Mantenga pulsado en el atajo del teclado Play/Pause.



# Solución de problemas

## **Si el dispositivo se bloquea:**

Pulse el botón ON/OFF durante 10 segundos o utilice la restauración de hardware. Para utilizar la restauración de hardware, pulse el botón de "restauración" con un objeto puntiagudo tal como un palillo de dientes.

## **Si el dispositivo no se enciende:**

1. Cargue el dispositivo.
2. Pulse el botón ON/OFF durante 10 segundos o utilice la restauración de hardware.

## **Si desea aumentar la duración de la batería:**

Disminuya el brillo de la pantalla y desactive las conexiones inalámbricas si no las utiliza.

## **Si el dispositivo funciona con demasiada lentitud:**

Cierre todas las aplicaciones que no esté utilizando.

## **Si la recepción WiFi es demasiado baja:**

Asegúrese de que no se encuentra lejos de la zona activa WiFi.

Actualizar el firmware del dispositivo: <http://www.archos.com/support>.

Restablecer la configuración de su conexión.

Póngase en contacto con el proveedor de la conexión WiFi.

## **Si desea restaurar el producto (ha olvidado la contraseña o quiere borrar todos sus parámetros) :**

1. Introduzca un clip en el botón Restaurar.
2. Mantenga el clip en el botón Restaurar y conecte el cable de alimentación al ARCHOS.





# Sommario

Contenuto della confezione.....	82
Avvio.....	83
Descrizione del ARCHOS.....	84
Connessione a una rete WiFi .....	86
Interfaccia Android™.....	88
ARCHOS mapping tool.....	92
Conoscere Android™.....	98
Soluzione dei problemi.....	100

Per ulteriori informazioni, consultare le FAQ su [www.archos.com](http://www.archos.com). Accertarsi di aver letto questo materiale prima di considerare l'eventuale restituzione del prodotto. Il problema riscontrato potrebbe non essere davvero un problema! Poiché i nostri prodotti vengono continuamente aggiornati e migliorati, è possibile che il software del dispositivo si presenti in modo leggermente diverso o con funzioni modificate rispetto a quanto presentato nella presente Guida rapida.

# Contenuto della confezione

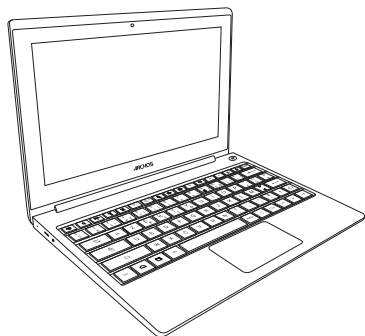

ARCHOS ArcBOOK



Guida dell'utente



Garanzia, note legali  
e sulla sicurezza



Cavo USB

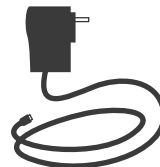

Caricatore

# Avvio

## Caricamento della batteria

Collegare il cavo di alimentazione fornito al dispositivo ARCHOS e a una presa a muro. Il dispositivo ARCHOS viene avviata la ricarica.

Durante la ricarica della batteria, la spia dell'indicatore di ricarica è rosso.

A batteria completamente carica, diventerà blu.

<b>Quando il dispositivo è spento</b>	Premere il pulsante ON/OFF [Acceso/Spento] per accenderlo.
<b>Quando il dispositivo è acceso</b>	<ul style="list-style-type: none"><li>- Premere brevemente il pulsante ON/OFF [Acceso/Spento] per attivare la modalità di riposo.</li><li>- Premere a lungo il pulsante ON/OFF [Acceso/Spento] per visualizzare le opzioni e selezionare per spegnerlo.</li></ul>

### CONSIGLI:

Durante il caricamento è possibile usare ARCHOS. Caricare completamente il dispositivo al primo utilizzo. Utilizzare solo il caricabatteria incluso.

Per ricevere un'assistenza più completa, registrare il prodotto.

Con un computer, andare su [www.archos.com/register](http://www.archos.com/register).



# Descrizione del ARCHOS

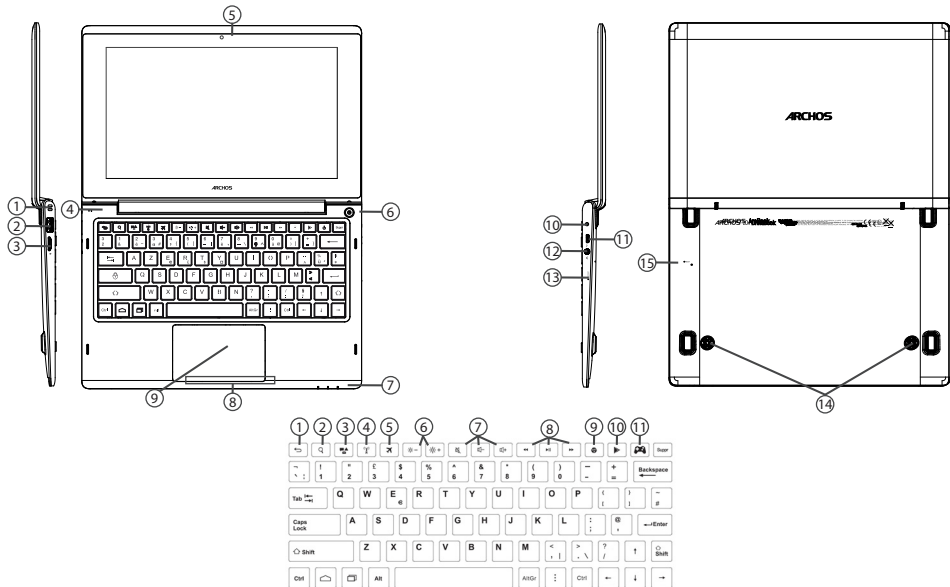



## Connettori del dispositivo

- |                        |                                       |                              |
|------------------------|---------------------------------------|------------------------------|
| ① Foro di bloccaggio   | ⑥ Pulsante ON/OFF                     | ⑪ Porta micro USB            |
| ② Porta USB            | ⑦ Indicatore di carica                | ⑫ Jack cuffie                |
| ③ Slot scheda micro SD | ⑧ Pulsante del pannello a sfioramento | ⑬ Pulsante Restore           |
| ④ Microfono            | ⑨ Pannello a sfioramento              | ⑭ Altoparlante               |
| ⑤ Webcam               | ⑩ Connettore alimentazione            | ⑮ Pulsante Reset [Reimposta] |

## Tasti di scelta rapida

- |                   |                        |              |
|-------------------|------------------------|--------------|
| ① Tasto Indietro  | ⑤ Tasto Modalità aereo | ⑨ Tasto WEB  |
| ② Tasto Ricerca   | ⑥ Tasto Luminosità     | ⑩ Tasto APPS |
| ③ Tasto Notifiche | ⑦ Tasto Volume         |              |
| ④ Tasto Wi-Fi     | ⑧ Tasti ARCHOS Music   |              |

# Connessione a una rete wireless

ATTENZIONE: Accertarsi di essere in una zona coperta da WiFi.



① Tocca e tieni premute le icone dell'orario e della batteria per visualizzare la barra di stato. Viene visualizzata una linea blu.



② Trascina la linea blu verso il basso per visualizzare il dashboard di stato.



③ Tocca "Wi-Fi off" nel dashboard di stato. Verrà visualizzata la pagina WiFi.

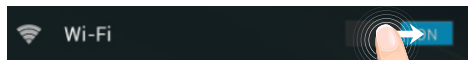

④ Se la rete WiFi è disattivata, spostare il pulsante WiFi sulla posizione "ON".

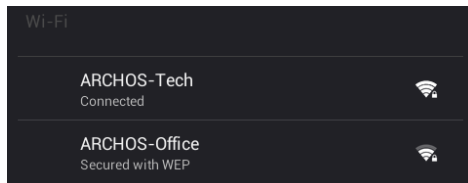



⑤ Una volta attivata la rete WiFi, ARCHOS scansionerà le reti WiFi presenti. Selezionare il nome di rete a cui si desidera connettersi. Le reti private vengono visualizzate con un lucchetto e richiedono l'inserimento di una password.

## Connessione rapida

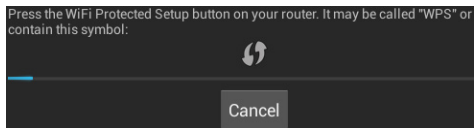
È possibile connettersi alla rete Wi-Fi tramite WiFi Protected Setup [Impostazione protetta Wi-Fi].



- 1 Premere il pulsante WiFi Protected Setup [Impostazione protetta Wi-Fi]  in Settings > Wireless & networks [Impostazioni > Wireless e reti].
- 2 Sul router Internet, premere il pulsante WiFi Protected Setup [Impostazione protetta Wi-Fi] denominato WPS o contenente il simbolo .

### SUGGERIMENTI:

- Quando si immette una password Wi-Fi, si consiglia di selezionare l'opzione "Show password" [Mostra password] per visualizzare i caratteri che si stanno digitando. Per ottenere la password Wi-Fi corretta (o le impostazioni) per la rete, contattare il fornitore di rete Wi-Fi. ARCHOS tenterà di connettersi automaticamente alla rete a cui l'utente si è connesso in precedenza, purché il Wi-Fi sia acceso e l'utente si trovi nel raggio di quella rete.
- Per mantenere la connessione Wi-Fi mentre il dispositivo è in modalità sospensione, selezionare l'icona Menu nella pagina "WiFi" [Wi-Fi]. Quindi, selezionare Advanced > Keep WiFi on during sleep > Always [Avanzate > Mantieni acceso Wi-Fi durante la sospensione > Sempre].

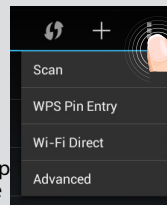

# Interfaccia Android™







- ① **Applicazioni Android™**  
> Selezionare per avviare un'applicazione.
- ② **Icone permanenti di accesso rapido alle app Android™**
- ③ **"Indietro"**
- ④ **"Home"**
- ⑤ **"Applicazioni recenti"**
- ⑥ **ARCHOS-mapping tool**
- ⑦ **"Tutte le applicazioni"**  
> Selezionare questa icona per visualizzare tutte le applicazioni e i widget si accenderanno sul vostro ARCHOS. Tutte le applicazioni scaricate sono qui.
- ⑧ **Google™ Search**  
> Selezionare la ricerca per testo o per voce.
- ⑨ **Barra di stato**  
> Che visualizza le notifiche e le impostazioni rapide.

# Interfaccia Android™

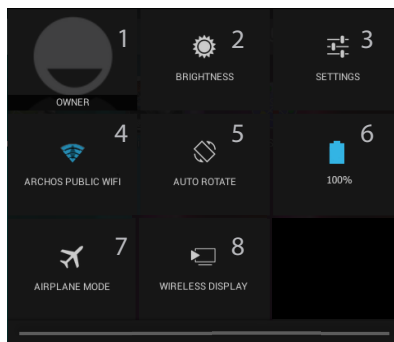

## 3:18 Impostazioni rapide

- 1 Utente corrente<sup>(1)</sup>
- 2 Per regolare la luminosità dello schermo.
- 3 Per accedere a tutte le impostazioni.
- 4 Per attivare/disattivare la connessione WiFi.
- 5 Per attivare/disattivare l'orientamento automatico dello schermo mentre si ruota ARCHOS .
- 6 Percentuale di batteria rimasta
- 7 Per attivare/disattivare tutte le connessioni wireless, specialmente in volo.
- 8 Per attivare il display wireless<sup>(2)</sup>

<sup>(1)</sup>Il nuovo supporto multi-utente per i tablet permette a utenti diversi di avere ciascuno il proprio spazio distinto e personalizzabile su un singolo dispositivo. Puoi aggiungere utenti in Settings > Device [Impostazioni > Dispositivo].

<sup>(2)</sup>Puoi condividere film, filmati di YouTube e tutto ciò che vedi sullo schermo su un televisore HDTV. Per ritrasmettere il contenuto del tuo schermo in modo semplice e veloce, devi collegare un adattatore display wireless a una qualsiasi TV abilitata HDMI

## Applicazioni recenti

Apri un elenco di immagini in miniatura delle applicazioni su cui si è recentemente lavorato:

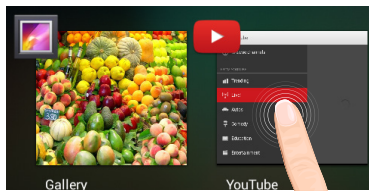

**Tocca:** per aprire una app.

**Tieni premuto:** visualizza le opzioni

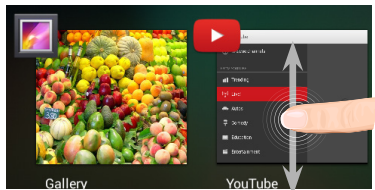

**Scorri verso l'alto o il basso:** chiudi un'app.

# ARCHOS mapping tool

ARCHOS mapping tool è un'applicazione installata sul ArcBook. Permette di collegare i comandi virtuali dei giochi ai comandi fisici del ArcBook utilizzando i comandi di mappatura.



un comando fisico

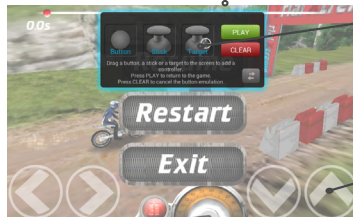

un comando di mappatura

un controllo virtuale

## Suggerimento 1:

All'interno di ARCHOS mapping tool, risiedono già profili di mappatura per oltre 100 giochi. Inoltre, molti giochi funzionano automaticamente con pulsanti fisici.

## Suggerimento 2:

Ogni volta in cui viene lanciato un gioco i cui comandi virtuali sono mappati, verrà selezionato automaticamente il corretto profilo di mappatura.



## Avvio di ARCHOS mapping tool

1. Lanciare un gioco.

Quando si arriva alla schermata iniziale, vengono visualizzati i comandi virtuali.

2. Selezionare l'icona ARCHOS mapping tool dalla barra di sistema.

IT



Icona ARCHOS mapping tool

Viene visualizzata la mappatura in sovrapposizione con l'interfaccia del mapping tool.



### Interfaccia ARCHOS mapping tool

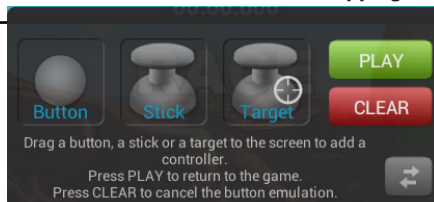

# ARCHOS mapping tool

## Posizionamento di un comando di mappatura

Trascinare tenendo premuto il comando di mappatura verso il pulsante virtuale desiderato.

Esistono tre tipi di controllo di mappatura



**Pulsante**

Per il tastierino direzionale ◀, ▶, ▼, ▲, i pulsanti X, Y, B, A e i pulsanti L1, R1, L2, R2, Start, Select.



**Stick**

Per gli stick direzionali analogici



**Target**

Per mirare al bersaglio con gli stick analogici. Di norma viene posizionato nell'area centrale dello schermo nei giochi di tiro.

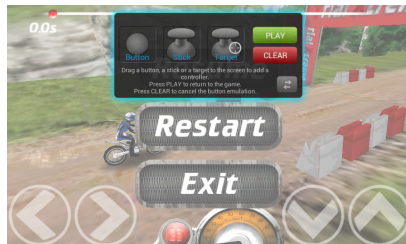

## Collegamento di un comando di mappatura a un comando fisico

1. Quando un comando di mappatura viene posizionato su un comando virtuale, vi verrà richiesto di selezionare il comando fisico desiderato a cui volete associarlo.

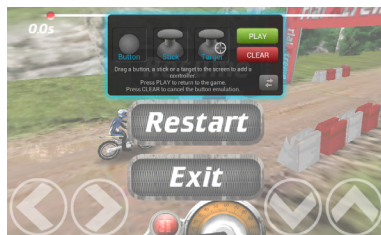

2. Una volta associato il comando fisico al comando di mappatura, il nome del comando fisico verrà visualizzato sul comando di mappatura.





# ARCHOS mapping tool

## Grandimento di un comando di mappatura

Alcuni comandi virtuali sono più grandi dei comandi di mappatura.

1. Ridimensionare con stick analogico destro.
2. Premere il pulsante A per confermare.

È possibile allargare i comandi di mappatura Stick e Target.

## Salvataggio dei parametri

Una volta mappati i comandi virtuali di un gioco, selezionare "Play"  (Riproduci) per confermare.

Il profilo viene salvato e associato a quel gioco.

La mappatura in sovraimpressione scompare ed è ora possibile giocare.

Ogni volta che si avvia il gioco, si è detto che l'emulazione dei tasti virtuali è attivo. Ciascuna mappatura è specifica per ciascun gioco.

Premere la notifica per visualizzare il profilo di mappatura del gioco. È possibile modificarlo o eliminarlo.









## D&R riguardanti la mappatura

È stato posizionato un comando di mappatura su un comando virtuale ma non è disponibile alcuna opzione?

1. Premere il comando di mappatura.  
Verrà visualizzata una casella del menu.
2. Selezionare l'icona  per impostare il comando di mappatura.

Si vuole rimuovere un comando di mappatura impostato?

1. Premere il comando di mappatura.  
Verrà visualizzata una casella del menu.
2. Selezionare l'icona  per rimuovere il comando di mappatura.

Si vuole rimuovere un profilo di mappatura impostato per un gioco?

1. Nell'interfaccia del gioco, selezionare l'icona ARCHOS mapping tool.
2. Da ARCHOS mapping tool, selezionare "Clear" (Cancella).
3. Selezionare "OK" per confermare.

### Opzioni di visualizzazione

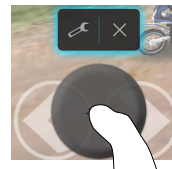

### Rimozione di un profilo di mappatura

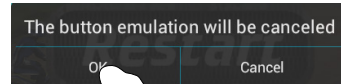
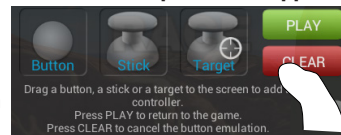



# Conoscere Android™

## **Utilizzo del pannello a sfioramento:**

Per premere brevemente: toccare il pannello a sfioramento una volta.

Per premere a lungo: tenere premuto il pulsante del pannello a sfioramento.

## **Schermata iniziale estesa:**

Navigare tra i vari pannelli della schermata iniziale sfiorando da sinistra o destra.

**Pannello a sfioramento:** Tenere premuto il pulsante del pannello a sfioramento muovendo il cursore con il pannello a sfioramento.

## **Spostare una voce della schermata iniziale:**

Selezionare e tenere il dito su di essa fino a quando si visualizzano le linee della griglia di posizionamento, quindi scorrere nella posizione desiderata e togliere il dito.

**Pannello a sfioramento:** Selezionare l'elemento con il cursore e tenere premuto il pulsante del pannello a sfioramento. Intanto, utilizzare il pannello a sfioramento per spostare l'elemento.

## **Rimuovere una voce della schermata iniziale:**

Selezionare e tenerla, scorrere il dito verso la parte superiore dello schermo e lasciare sull'icona "Rimuovi" X.

**Pannello a sfioramento:** Selezionare l'elemento con il cursore e tenere premuto il pulsante del pannello a sfioramento. Intanto, utilizzare il pannello a sfioramento per spostarlo verso la parte superiore dello schermo e rilasciarlo sull'icona Remove [Rimuovi] X.

## **Disinstallare una voce:**

Dalle schermate "Tutte le applicazioni", selezionare e tenere, scorrere il dito verso la parte superiore dello schermo e lasciare su Cestino disinstalla.

**Pannello a sfioramento:** Dalle schermate All apps [Tutte le applicazioni], selezionare





l'elemento con il cursore e tenere premuto il pulsante del pannello a sfioramento. Intanto, utilizzare il pannello a sfioramento per spostarlo verso la parte superiore dello schermo e rilasciarlo sull'icona Bin [Cestino] .

### **Creare cartelle di applicazioni:**

Lasciare un'icona di applicazione su un'altra icona della schermata iniziale e le due icone si combineranno.

### **Widget:**

Selezionare l'icona "Tutte le applicazioni" della schermata iniziale. Toccare i "Widget" sulla parte superiore dello schermo. Dalla schermata principale "Widget", è possibile spostare i widget proprio come si fa per le icone delle applicazioni.

### **Modificare lo sfondo:**

Tenere il dito sulla schermata su una posizione vuota, quindi selezionare dall'elenco.

**Pannello a sfioramento:** Tenere premuto il pulsante del pannello a sfioramento in uno spazio vuoto della schermata Home.

### **Blocco del touchscreen:**

Dal pannello delle impostazioni rapide nella barra di stato, selezionare "Impostazioni". Scorrere e selezionare protezione. Bloccare il touchscreen. Selezionare il tipo di blocco che si desidera usare. Dopo aver impostato un blocco, un lucchetto viene visualizzato ogni volta che lo schermo si apre, richiedendo sequenza, PIN o altra chiave specificata.

### **Apertura dell'applicazione ARCHOS Music:**

Premere a lungo il tasto di scelta rapida Riproduci/Pausa sulla tastiera.



# Soluzione dei problemi

## **Nel caso in cui il dispositivo sembri bloccato:**

Premere il pulsante ON/OFF per 10 secondi o usare l'azzeramento Hardware. Per usare l'azzeramento Hardware, premere il pulsante «azzeramento foro» usando un oggetto appuntito come uno stuzzicadenti.

## **Nel caso in cui il dispositivo non si accenda:**

1. Caricare il dispositivo.
2. Premere il pulsante ON/OFF per 10 secondi o usare l'azzeramento Hardware.

## **Se si desidera estendere la vita della batteria:**

Diminuire la luminosità dello schermo e spegnere le connessioni wireless non in uso.

## **Se il dispositivo funziona troppo lentamente:**

Chiudere tutte le applicazioni non attualmente in uso.

## **Se la ricezione WiFi è troppo lenta:**

Accertarsi di non essere troppo lontani dal punto WiFi.  
Aggiornare il firmware del dispositivo: <http://www.archos.com/support>.  
Ripristinare le impostazioni di connessione.  
Contattare il fornitore della connessione WiFi.

## **Se si desidera ripristinare il prodotto (password dimenticata? cancellare tutte le impostazioni?):**

1. Inserire una clip di carta nel pulsante Restore.
2. Tenere la clip di carta nel pulsante Restore e collegare il cavo di alimentazione al dispositivo ARCHOS.



# Inhoudsopgave

Wat zit er in de doos?.....	102
Aan de slag.....	103
Beschrijving ARCHOS.....	104
WiFi-netwerkverbinding.....	106
De Android™-Interface.....	108
Archos Mapping Tool.....	112
Vertrouwd raken met Android™ .....	118
Problemen oplossen.....	120

Raadpleeg voor meer informatie de veelgestelde vragen (FAQ's) op [www.archos.com](http://www.archos.com). Zorg ervoor dat u ze leest alvorens te overwegen het product te retourneren. Uw probleem kan wel eens een probleempje blijken. Omdat we onze producten voortdurend aanpassen en verbeteren, kan de software van uw apparaat er een beetje anders uitzien of een licht gewijzigde functionaliteit hebben dan voorgesteld in deze Snelstartgids.

# Wat zit er in de doos?

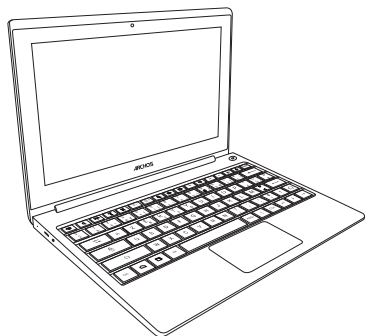

ARCHOS ArcBOOK



Gebruikershandleiding



Garantie, wettelijke mededelingen en veiligheidsvoorschrift



USB-kabel

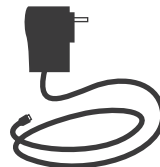

Lader

# Aan de slag

## De batterijen laden

1. Laad uw apparaat op door de stekker van uw voedingskabel in de stroomaansluiting te steken. Het ARCHOS-apparaat begint op te laden.

Wanneer de batterij wordt opgeladen, brandt er een rood indicatielampje.

Het wordt blauw als de accu helemaal opgeladen is.

<b>Wanneer het apparaat is uitgeschakeld</b>	Druk op de AAN/UIT-knop om het apparaat in te schakelen.
--	--

<b>Wanneer het apparaat is ingeschakeld</b>	<ul style="list-style-type: none"><li>- Druk kort op de AAN/UIT-knop om het apparaat in stand-by te zetten.</li><li>- Druk lang op de AAN/UIT-knop om opties weer te geven en uitschakelen te kiezen.</li></ul>
---	---

### TIPS:

U kunt uw ARCHOS gebruiken terwijl hij wordt opgeladen. Laad het apparaat de eerste keer helemaal op. Gebruik uitsluitend de meegeleverde oplader.

Registreer uw product om de volledige service te ontvangen. Als u een computer hebt, ga dan naar [www.archos.com/register](http://www.archos.com/register).



# Beschrijving ARCHOS

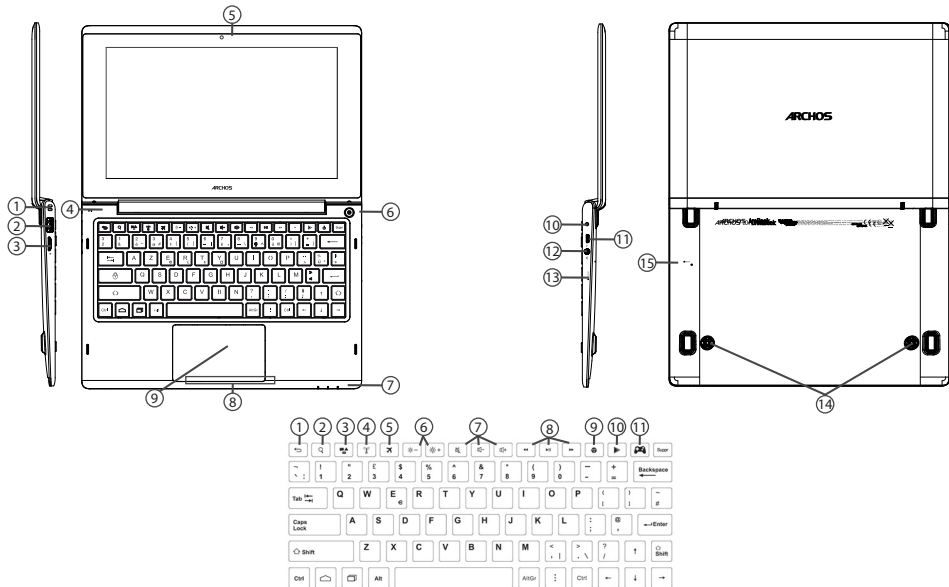





## Aansluitingen

- |                       |                       |                            |
|-----------------------|-----------------------|----------------------------|
| ① Vergrendelopening   | ⑥ AAN/UIT-knop        | ⑪ Micro-USB-poort          |
| ② USB-poort           | ⑦ Oplaadlampje        | ⑫ Hoofdtelefoonaansluiting |
| ③ Micro-SD-kaartsleuf | ⑧ Touchpadknop        | ⑬ Restore-knop             |
| ④ Microfoon           | ⑨ Touchpad            | ⑭ Luidsprekers             |
| ⑤ Webcam              | ⑩ Voedingsaansluiting | ⑮ Reset-knop               |

## Sneltoetsen van toetsenbord

- |               |                       |             |
|---------------|-----------------------|-------------|
| ① Vorige-knop | ⑤ Vliegtuigmodusknop  | ⑨ WEB-knop  |
| ② Zoekknop    | ⑥ Helderheidknoppen   | ⑩ APPS-knop |
| ③ Meldingknop | ⑦ Volumeknoppen       |             |
| ④ WiFi-knop   | ⑧ ARCHOS-muzieknoppen |             |

# WiFi-netwerkverbinding

WAARSCHUWING: Zorg ervoor dat u zich in een WiFi-zone bevindt.



① Houd uw vingers op de pictogrammen voor de tijd en de batterij om de statusbalk weer te geven. Er wordt een blauwe streep weergegeven.



② Sleep de blauwe streep naar beneden om de statusinformatie weer te geven.



③ Tik op "WiFi off" [WiFi uit] in de statusinformatie. De WiFi-pagina wordt weergegeven.



④ Als de WiFi is uitgeschakeld, schuift u de WiFi-schakelaar in de stand "AAN".

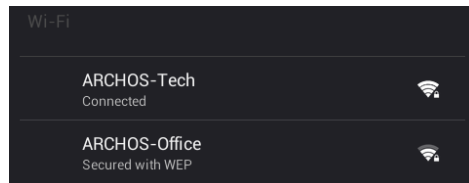



⑤ Zodra de WiFi is ingeschakeld, gaat de ARCHOS zoeken naar WiFi-netwerken die zich binnen het bereik bevinden. Tik op de naam van het netwerk waarmee u verbinding wilt maken. Privé-netwerken worden weergegeven met een slotje en vragen u om uw wachtwoord in te voeren.

## Snel verbinding maken

U kunt verbinding maken met uw WiFi-netwerk via WiFi Protected Setup (Beveiligde WiFi-configuratie).

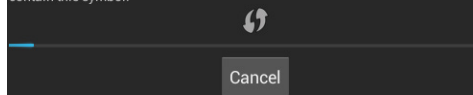
Press the WiFi Protected Setup button on your router. It may be called "WPS" or contain this symbol:



- ① Druk op de knop WiFi Protected Setup (Beveiligde WiFi-configuratie)  bij Settings > Wireless & networks (Instellingen > Draadloos & Netwerken).
- ② Druk op uw internetrouter op de knop voor beveiligde WiFi-configuratie. Deze knop wordt aangeduid met de letters WPS of met het symbool .

### TIPS:

- Tijdens het invoeren van een WiFi-wachtwoord kunt u het best "Show password" (Wachtwoord weergeven) selecteren zodat u de tekens tijdens het typen ziet. Neem voor het juiste wachtwoord (of voor de instellingen) van uw WiFi-netwerk contact op met uw WiFi-provider. Als WiFi is ingeschakeld en u zich binnen het bereik van een netwerk bevindt waarmee u eerder was verbonden dan probeert de ARCHOS automatisch opnieuw een verbinding tot stand te brengen.
- Om uw WiFi-verbinding ingeschakeld te houden als het apparaat in stand-by is, selecteert u het Menu-pictogram op de WiFi-pagina. Vervolgens selecteert u Advanced > Keep WiFi on during sleep > Always [Geavanceerd > WiFi aan in stand-by > Altijd]

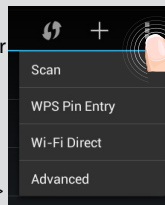

# De Android™-Interface





- ① **Android™-apps**  
> Tik erop om een applicatie te starten.
- ② **Snelkoppelingen van permanente Android™-apps**
- ③ **"Terug"**
- ④ **"Startpagina"**
- ⑤ **"Recente apps"**
- ⑥ **ARCHOS-mapping tool**
- ⑦ **"Knop Alle" Apps**  
> Tik op dit pictogram om alle applicaties en widgets weer te geven die op uw ARCHOS zijn geïnstalleerd. Al uw gedownloade applicaties bevinden zich hier.
- ⑧ **Google™ Search**  
> Tik voor zoeken op tekst of zoeken met stem.
- ⑨ **Statusbalk**  
> Geeft meldingen en snelinstellingen weer.

# De Android™-Interface

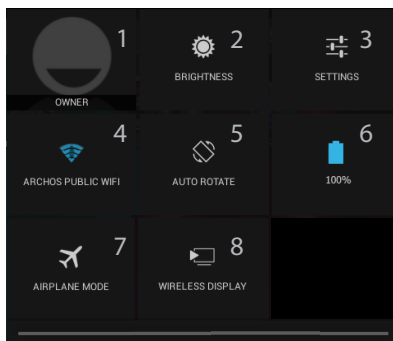

## 3:18 De Snelinstellingen

- 1 Huidige gebruiker<sup>(1)</sup>
- 2 Om de helderheid van het scherm aan te passen.
- 3 Om al uw instellingen te openen.
- 4 Om uw WiFi-verbinding aan/uit te zetten.
- 5 Om de automatische oriëntatie van het scherm te activeren/deactiveren als u uw ARCHOS draait.
- 6 Percentage batterijlading
- 7 Om alle draadloze verbindingen te activeren/deactiveren, in het bijzonder tijdens het vliegen.
- 8 Per attivare il display wireless<sup>(2)</sup>

<sup>(1)</sup>Nieuwe tabletondersteuning voor meerdere gebruikers waarbij iedere gebruiker zijn eigen ruimte op de tablet kan maken en aanpassen. Voeg gebruikers toe bij Settings > Device [Instellingen > Apparaat]

<sup>(2)</sup>Puoi condividere film, filmati di YouTube e tutto ciò che vedi sullo schermo su un televisore HDTV. Per ritrasmettere il contenuto del tuo schermo in modo semplice e veloce, devi collegare un adattatore display wireless a una qualsiasi TV abilitata HDMI.



## Recente apps

Hiermee opent u een lijst van miniatuurafbeeldingen van apps waarmee u onlangs hebt gewerkt:

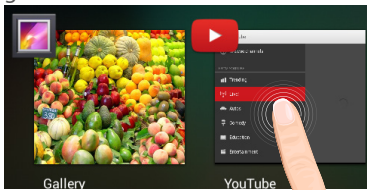

**Aanraken:** een app openen.

**Vasthouden:** opties weergeven

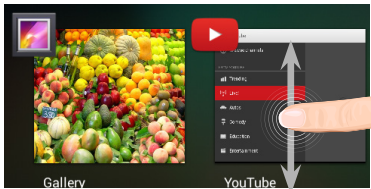

**Op en neer vegen:** een app sluiten.

# ARCHOS-mapping tool

De ARCHOS-mappingtool is een applicatie die op de ArcBook is geïnstalleerd. Hiermee kunt u de virtuele besturing van games aan de fysieke besturingsknoppen van de ArcBook koppelen via mapping-besturing.

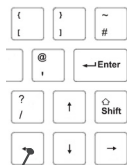

fysieke besturing



mappingbesturing

virtuele besturing

## Tip 1:

De ARCHOS-mappingtool bevat al mappingprofielen voor meer dan 100 games. Veel games werken al automatisch met de fysieke besturingsknoppen.

## Tip 2:

Als u een game start waarvan de virtuele besturing al is 'gemapped' dan wordt automatisch het juiste mappingprofiel geselecteerd.



## De ARCHOS-mappingtool starten

1. Open een game.

In het beginscherm worden de virtuele besturingsknoppen weergegeven.

2. Selecteer het pictogram van de ARCHOS-mappingtool in de systeembalk.



Pictogram van ARCHOS-mappingtool

Het mappingvenster met de interface van de mappingtool wordt weergegeven.



### Interface van ARCHOS-mappingtool

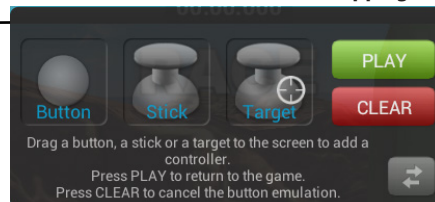

# ARCHOS-mapping tool

## Mappingknoppen plaatsen

Sleep een mappingknop naar de gewenste virtuele knop.

Er zijn drie type mappingknoppen.



Button

Knop voor de richtingsknoppen ◀, ▶, ▼, ▲, de knoppen X, Y, B, A en de knoppen L1, R1, L2, R2, Start, Select.



Stick

Voor richtingbesturing met de analoge sticks.



Target

Vizier om op het doelwit te richten met de analoge sticks. Bij schietgames bevindt het vizier zich meestal in het midden van het scherm.

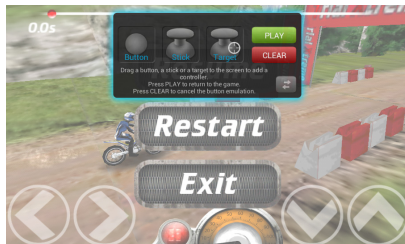



## Mappingknoppen koppelen aan fysieke knoppen

1. Wanneer een mappingknop op een virtuele knop is geplaatst, wordt u gevraagd om de fysieke knop te selecteren waaraan u de mappingknop wilt koppelen.

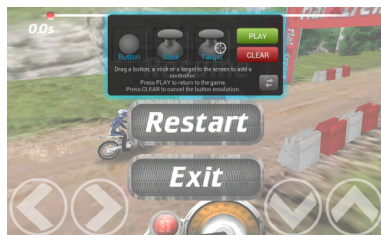

NL

2. Zodra een fysieke knop met een mappingknop is gekoppeld, wordt de naam van de fysieke knop op de mappingknop weergegeven.





# ARCHOS-mapping tool

## Mappingknoppen vergroten

Sommige virtuele knoppen zijn groter dan de mappingknoppen.

1. Formaat wijzigen met de rechter analoge stick.
2. Druk op de A-knop om te bevestigen.

U kunt alleen de mappingknoppen Stick en Target vergroten.

## Parameters opslaan

Nadat u de virtuele knoppen van een game hebt "gemapped", selecteert u "Play" [Spelen]



PLAY

om op te slaan. Het profiel wordt opgeslagen als profiel van de geopende game.

Het mappingvenster verdwijnt en u kunt de game spelen.

Iedere keer dat u de game start, wordt het volgende bericht weergegeven.

Wanneer je het spel start, wordt u geïnformeerd dat de emulatie van virtuele controles wordt uitgevoerd. Iedere mapping is specifiek voor de betreffende game.

Druk op de melding om het mappingprofiel van de game weer te geven. U kunt het profiel wijzigen of wissen.

## Q&A over mapping

U hebt een mappingknop op een virtuele knop geplaatst, maar er zijn geen opties beschikbaar?

1. Druk op de mappingknop.

Er wordt een menuvak weergegeven.

2. Selecteer het pictogram  om de mappingknop in te stellen.

U wilt een ingestelde mappingknop verwijderen?

1. Druk op de mappingknop.

Er wordt een menuvak weergegeven.

2. Selecteer het pictogram  om de mappingknop te verwijderen.

U wilt het mappingprofiel van een game verwijderen?

1. In de interface van het spel, selecteert u het pictogram van de mapping tool.

2. In de ARCHOS-mappingtool selecteert u "Clear" [Wissen].

3. Selecteer "OK" om te bevestigen.

### Weergave-opties

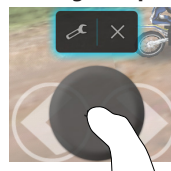

### Mappingprofiel verwijderen

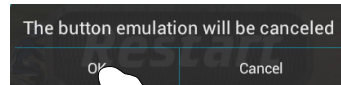
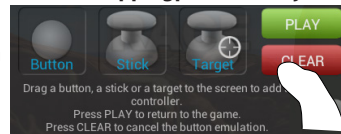



# Vertrouwd raken met Android™

---

## **Gebruik van de touchpad:**

Voor kort indrukken: tik één maal op de touchpad.

Voor lang indrukken: houd uw vinger op de touchpad.

## **Het uitgebreide startscherm:**

Navigeren tussen de verschillende startschermpanelen door er van links en rechts overheen te vegen.

**Touchpad:** Houd de touchpadknop ingedrukt en verplaats de cursor met de touchpad.

## **Het verplaatsen van een item op het startscherm:**

Tik en houd uw vinger op zijn plaats tot de positioneringsrasterlijnen verschijnen, dan schuift u deze naar de gewenste locatie en laat uw vinger vervolgens weer los.

**Touchpad:** Kies een item met de cursor en houd de touchpadknop ingedrukt. Houd de touchpadknop ingedrukt en verplaats het item met de touchpad.

## **Het verwijderen van een item op het startscherm:**

Tik en houd uw vinger op het item en schuif dit vervolgens naar de bovenkant van het scherm en zet het op het pictogram "Verwijderen".

**Touchpad:** Kies een item met de cursor en houd de touchpadknop ingedrukt. Houd de touchpadknop ingedrukt en verplaats het item met de touchpad naar de bovenkant van het scherm waar u het loslaat boven het pictogram voor Verwijderen X.

## **Verwijderen van een item:**

Tik in de schermen "Alle apps" op het item en houd uw vinger daar, schuif vervolgens uw vinger in de richting van de bovenkant van het scherm en plaats het item op de prullenbak "Verwijderen".



**Touchpad:** Kies in het scherm "Alle apps" een item met de cursor en houd de touchpadknop ingedrukt. Houd de touchpadknop ingedrukt en verplaats het item met de touchpad naar de bovenkant van het scherm waar u het loslaat boven het pictogram van de Prullenbak.

**Het aanmaken van applicatiemappen:**

Plaats op een startscherm het ene app-pictogram op het andere, en de twee pictogrammen worden gecombineerd.

**Widgets:**

Tik in uw startscherm op het pictogram "Alle apps". Tik op "Widgets" aan de bovenkant van het scherm. Vanaf het Widgets-hoofdscherm kunt u widgets op dezelfde manier verplaatsen als app-pictogrammen.

**Uw wallpaper wijzigen:**

Houd uw vinger op het scherm op een lege plek en maak vervolgens een selectie uit de lijst.

**Touchpad:** Houd de touchpadknop ingedrukt op een lege plaats in het beginscherm.

**Het vergrendelen van het aanraakscherm:**

Tik vanuit het snelinstellingen-dashboard op instellingen. Scroll naar beneden en tik op veiligheid. Tik op Scherm vergrendelen. Tik op het type slot dat u wilt gebruiken. Nadat u hier een slot hebt ingesteld, wordt er een vergrendelscherm weergegeven wanneer uw scherm 'wakker' wordt, dat om het patroon, de PIN of een andere specifieke toets vraagt.

**Open een ARCHOS-muziekapp**

Druk lang op de sneltoets voor Afspelen/Pauze op het toetsenbord.



# Problemen oplossen

## **Als uw apparaat vast zit:**

Druk gedurende 10 seconden op de AAN/UIT-knop of maak gebruik van de hardware-reset. Druk voor de hardware-reset op de knop 'in het gaatje' met behulp van een scherp voorwerp zoals een tandenstoker.

## **Als uw apparaat niet inschakelt:**

1. Laad uw apparaat op.
2. Druk gedurende 10 seconden op de AAN/UIT-knop of maak gebruik van de hardware-reset.

## **Als u de levensduur van uw batterij wilt verlengen:**

Verminder de helderheid van het scherm en schakel de draadloze verbindingen uit indien deze niet in gebruik zijn.

## **Als uw apparaat te traag werkt:**

Sluit alle applicaties die op dat moment niet worden gebruikt.

## **Als uw WiFi-ontvangst te laag is:**

Zorg ervoor dat u zich niet ver van de WiFi-hotspot bevindt.  
Update de firmware van het apparaat: <http://www.archos.com/support>.  
Reset de instellingen van uw WLAN-verbinding.  
Neem contact op met uw WiFi-verbindingsprovider.

## **Het product herstellen (wachtwoord vergeten? alle instellingen wissen?):**

1. Steek een paperclip in de knop Restore.
2. Houd de paperclip in de knop Restore en sluit het voedingskabel aan op de ARCHOS.







# Índice

Conteúdo da embalagem.....	122
Início.....	123
Descrição do ARCHOS.....	124
Ligação a uma rede WiFi .....	126
A interface Android™ .....	128
ARCHOS mapping tool.....	132
Familiarizar-se com Android™ .....	138
Resolução de problemas.....	140

PT

Para obter mais informações, consulte as Perguntas frequentes em [www.archos.com](http://www.archos.com). Certifique-se de que os consulta antes de colocar a hipótese de devolver qualquer produto. O seu problema pode ser insignificante. Como muitas vezes atualizamos e melhoramos os nossos produtos, o seu software do dispositivo pode ter uma aparência ligeiramente diferente ou funcionalidades modificadas das apresentadas neste Guia de Início Rápido.



# Conteúdo da embalagem

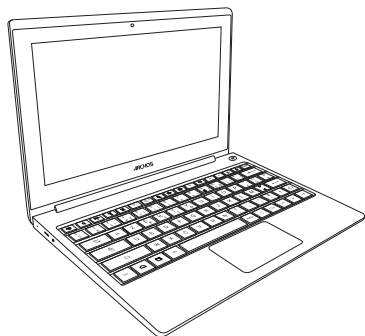

ARCHOS ARCBOOK



Guia do usuário



Garantia, avisos legais e de segurança



Cabo USB

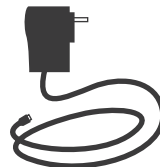

Carregador

# Início

## Carregar a bateria

Conecte o cabo de alimentação fornecido ao conector de alimentação ARCHOS e para uma tomada de parede. O aparelho ARCHOS irá ligar e será iniciado o carregamento. O indicador de carga acende-se a vermelha enquanto a bateria está a carregar. Ficará azul após o carregamento da bateria.

<b>Quando o dispositivo está desligado</b>	Prima o botão Ligar/Desligar para ligá-lo.
<b>Quando o dispositivo está ligado</b>	<ul style="list-style-type: none"><li>- Prima rapidamente o botão Ligar/Desligar para entrar em modo suspensão.</li><li>- Mantenha o botão Ligar/Desligar premido até apresentar as opções e selecione a opção para desligá-lo.</li></ul>

### SUGESTÕES:

Pode utilizar o seu aparelho ARCHOS enquanto este está a carregar. Carregue o dispositivo completamente antes de usá-lo pela primeira vez. Use apenas o carregador fornecido. Para receber uma assistência mais completa, registe o seu produto. No caso de um computador, vá a [www.archos.com/register](http://www.archos.com/register).



# Descrição do dispositivo

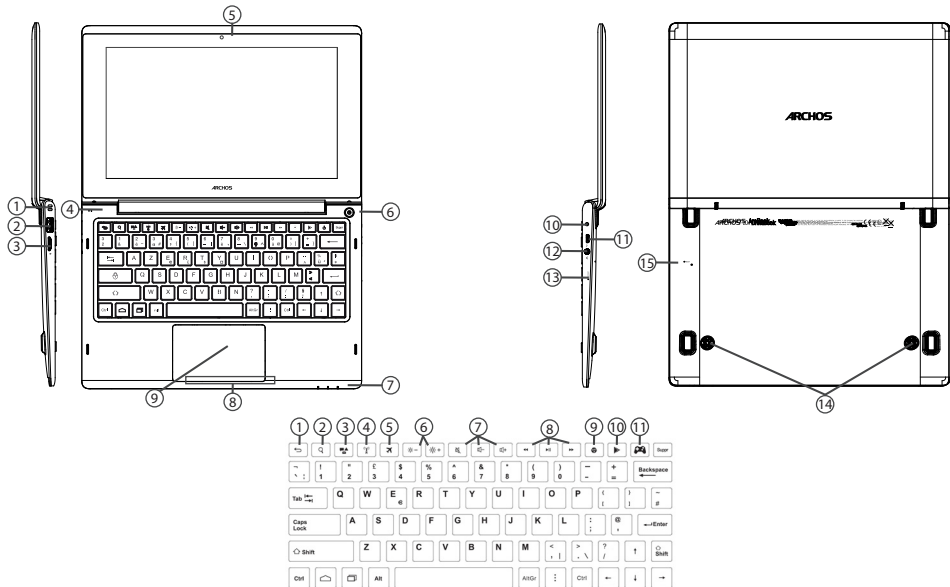



## Ligações do dispositivo

- |                              |                         |                              |
|------------------------------|-------------------------|------------------------------|
| ① Ranhura para bloqueio      | ⑥ Botão Ligar/Desligar  | ⑪ Porta Micro USB            |
| ② Porta USB                  | ⑦ Indicador de carga    | ⑫ Entrada para auscultadores |
| ③ Ranhura do cartão Micro SD | ⑧ Botão do painel tátil | ⑬ Recovery do produto        |
| ④ Microfone                  | ⑨ Painel tátil          | ⑭ Altifalantes               |
| ⑤ Webcam                     | ⑩ Ficha de alimentação  | ⑮ Botão Repor                |

PT

## Botões de atalho do teclado

- |                      |                       |              |
|----------------------|-----------------------|--------------|
| ① Botão Voltar       | ⑤ Botão Modo Avião    | ⑨ Botão WEB  |
| ② Botão Pesquisar    | ⑥ Botão Brilho        | ⑩ Botão APPS |
| ③ Botão Notificações | ⑦ Botões de Volume    |              |
| ④ Botão Wi-Fi        | ⑧ Botões ARCHOS Music |              |

# Ligação a uma rede WiFi

AVISO: Certifique-se de que se encontra numa zona WiFi.

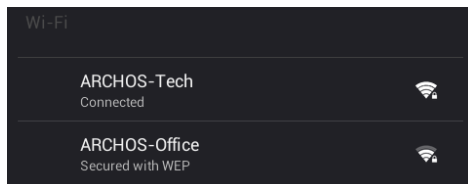

① Toque e mantenha premidos os ícones do Tempo e bateria para revelar a barra de estados. Será exibida uma linha azul.

② Puxe a linha azul para baixo para exibir o painel de controlo.

③ Toque em “WiFi off [Wi-Fi desligado]” no painel de controlo.

④ Será exibida a página do WiFi. Se a funcionalidade WiFi estiver desligada, deslize o comutador WiFi para a posição “LIGADO”.

⑤ Depois da funcionalidade WiFi estar ligada, o ARCHOS irá procurar redes WiFi ao alcance. Toque no nome da rede à qual pretende ligar-se.

As redes privadas aparecem com o ícone de um cadeado e irão requerer a introdução da sua palavra-passe.

## Ligação rápida

Pode ligar à sua rede Wi-Fi através de uma configuração protegida Wi-Fi (WPS).

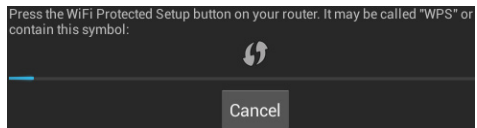

① Prima o botão configuração de protegida Wi-Fi (WPS)  em "Settings" (Definições) >

② "Wireless & networks" (Wi-Fi e redes).  
Prima o botão configuração protegida Wi-Fi (WPS) no seu router da Internet. Poderá ter o símbolo .

PT

### SUGESTÕES:

- Recomendamos a seleção da opção "Show password" (mostrar palavra-passe) quando introduz a palavra-passe da rede Wi-Fi, para visualizar os caracteres introduzidos. Contacte o seu fornecedor de Internet (e Wi-Fi), se não souber a palavra-passe ou as definições da sua rede Wi-Fi. Se estiver ao alcance de uma rede Wi-Fi ao qual já tenha ligado o ARCHOS e ela esteja ligada, o ARCHOS tentará ligar-se automaticamente.
- Para manter a ligação Wi-Fi ligada enquanto o dispositivo está suspenso, seleccione o ícone Menu na página Wi-Fi. Depois seleccione "Advanced" (avançado) > "Keep WiFi on during sleep" (manter Wi-Fi ligada enquanto suspenso) > "Always" (sempre).

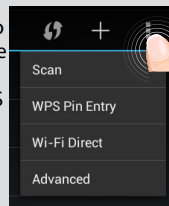

# A Interface Android™







- ① **Aplicações Android™**  
> Toque para iniciar uma aplicação.
- ② **Atalhos permanentes em aplicações Android™**
- ③ **"Anterior"**
- ④ **"Ecrã Principal"**
- ⑤ **"Aplicações recentes"**
- ⑥ **ARCHOS mapping tool**
- ⑦ **"Todas as Aplicações"**  
> Toque neste ícone para visualizar todas as aplicações e widgets instalados no seu ARCHOS. Estão aqui todas as aplicações descarregadas.
- ⑧ **Google™ Search**  
> Toque para efectuar uma pesquisa de texto ou uma busca por voz.
- ⑨ **Barra do estado**  
> Apresenta notificações e definições rápidas.

# A Interface Android™

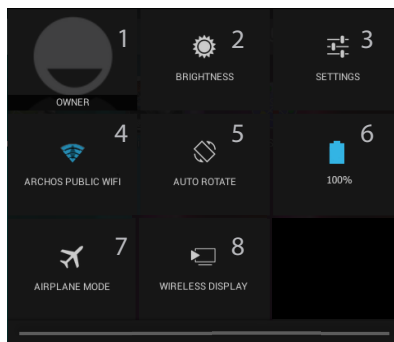

## 3:18 As Definições rápidas

- 1 Utilizador atual<sup>(1)</sup>
- 2 Para ajustar o brilho do ecrã.
- 3 Para aceder a todas as suas definições.
- 4 Para ligar/desligar a sua ligação WiFi.
- 5 Para activar/desactivar a orientação automática do ecrã enquanto roda o ARCHOS.
- 6 Ver a percentagem de bateria que resta
- 7 Para activar/desactivar todas as ligações sem fios, especialmente durante voos.
- 8 Para ligar a visualização sem fios<sup>(2)</sup>.

<sup>(1)</sup>O novo suporte multiutilizador para permite que diferentes utilizadores tenham áreas de trabalho separadas e personalizadas no mesmo dispositivo. Pode adicionar utilizadores em Settings > Device [Definições > Dispositivo]

<sup>(2)</sup>Pode partilhar filmes, vídeos do YouTube e tudo o que estiver no seu ecrã com uma televisão HD. Basta que ligue o um adaptador de visualização sem fios numa TV com HDMI e poderá espelhar tudo o que está no ecrã do seu tablet, rápido e facilmente.

## Aplicações recentes

Abre uma lista de imagens em tamanho reduzido das aplicações que utilizou recentemente:



**Toque:** para abrir uma aplicação

**Manter premido:** exibir opções

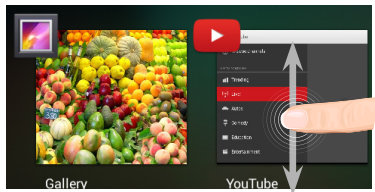

**Deslizar para cima ou para baixo:** fechar uma aplicação

# ARCHOS mapping tool

A ferramenta de mapeamento ARCHOS é uma aplicação pré-instalada no seu ArcBook. Permite-lhe associar os controlos virtuais dos jogos aos controlos físicos do ArcBook, usando uma função de mapeamento.



um  
controlo  
físico



um  
controlo de  
mapeamento

um  
controlo  
virtual

## Dica 1:

Dentro da ferramenta de mapeamento ARCHOS existem perfis mapeados para mais de 100 jogos. Além disso, há muitos jogos que funcionam automaticamente com os botões físicos.

## Dica 2:

Sempre que executar um jogo que tenha controlos virtuais mapeados, será selecionado o perfil de mapeamento adequado.

## Iniciar a ARCHOS mapping tool

1. Execute um jogo.

No ecrã inicial, são exibidos os controlos virtuais.

2. Selecione o ícone da ferramenta de mapeamento ARCHOS a partir da barra de sistema.



Ícone da ARCHOS mapping tool

A camada de mapeamento é exibida juntamente com a interface da ferramenta.



### Interface da ARCHOS mapping tool

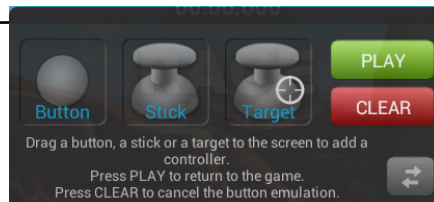

# ARCHOS mapping tool

## Posicionar um controlo de mapeamento

Segure e arraste o tipo de controlo que deseja mapear no botão virtual.

Há três tipos de controlos para mapeamento



Botão

Serve para o botão direcional, ◀, ▶, ▼, ▲, botões, X, Y, B e A, e botões L1, R1, L2, R2, Start e Select.



Manípulo

Serve para os manípulos analógicos.



Mira

Serve para mirar com os analógicos. Normalmente está colocado na área central do ecrã nos jogos de tiros.

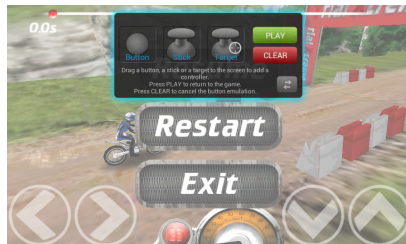



## Associar um controlo de mapeamento a um controlo físico

1. Quando um controlo de mapeamento é colocado sobre um controlo físico, será solicitado a seleccionar o controlo físico que deseja associar.

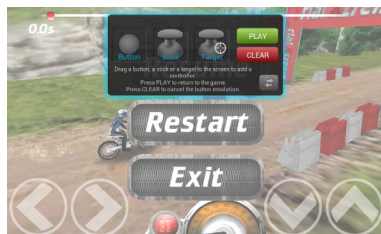

PT

2. Depois de associar um controlo físico a um controlo de mapeamento, o nome do controlo físico aparecerá no controlo de mapeamento.



135





# ARCHOS mapping tool

## Aumentar um controlo de mapeamento

Alguns controlos virtuais são maiores que os controlos de mapeamento.

1. Redimensionar com o analógico direito.
2. Pressione o botão A para confirmar.

Apenas pode aumentar os controlos de mapeamento do tipo Stick (Manípulo) e Target (Mira).

## Guardar os seus parâmetros

Assim que terminar de mapear os controlos virtuais de um jogo, seleccione “Play” (Jogar)

 para confirmar.

O perfil é guardado e associado ao jogo.

A camada de mapeamento desaparece e pode jogar à vontade.

Sempre que você iniciar o jogo, você é informado de que a emulação de controlos virtuais está sendo executado. Cada mapeamento é específico a um jogo.

Prima a notificação para mostrar o perfil de mapeamento do jogo. Pode modificá-lo ou eliminá-lo.



## Perguntas e respostas sobre o mapeamento

Colocou um controlo de mapeamento sobre um controlo virtual, mas não há opções disponíveis?

1. Pressione o controlo de mapeamento.  
Aparece um menu.
2. Selecione o ícone  para configurar o mapeamento.  
Deseja remover um mapeamento criado por si?

1. Pressione o controlo de mapeamento.  
Aparece um menu.
2. Selecione o ícone  para remover o mapeamento.  
Deseja remover um perfil de mapeamento de um jogo?
1. Na interface do jogo, selecione o ícone da ARCHOS mapping tool.
2. Selecione "Clear" (Limpar), a partir da ferramenta de mapeamento ARCHOS.
3. Selecione "OK" para confirmar.

### Opções de visualização

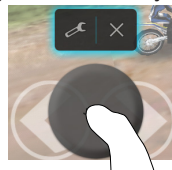

### Remover um perfil de mapeamento

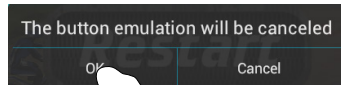
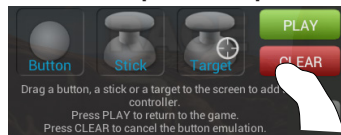

PT



# Familiarizar-se com Android™

## **Utilizar o painel tátil:**

Para premir rapidamente: toque uma vez no painel tátil.

Para manter premido: mantenha o dedo no botão do painel tátil.

## **O ecrã inicial alargado:**

Navegue entre os diferentes painéis do ecrã inicial movendo-os para a esquerda e para a direita.

**Painel tátil:** Mantenha o botão do painel tátil premido, enquanto move o cursor com o painel tátil.

## **Mover um item do ecrã inicial:**

Toque continuamente com o dedo no mesmo até aparecer a grelha de posicionamento; em seguida, deslize-o para a posição pretendida e solte o dedo.

**Painel tátil:** Selecione o item com o cursor e mantenha o botão do painel tátil premido. Utilize o painel tátil para mover o item, enquanto mantém o botão do painel tátil premido.

## **Remover um item do ecrã inicial:**

Toque continuamente no mesmo, deslize o seu dedo para o topo do ecrã e largue-o sobre o ícone "Remover".

**Painel tátil:** Selecione o item com o cursor e mantenha o botão do painel tátil premido.

Mantendo o botão do painel tátil premido, utilize o painel tátil para mover o item até ao topo do ecrã, depois solte-o por cima do ícone Remover X.

## **Desinstalar um item:**

A partir do ecrã "Todas as aplicações", toque continuamente no mesmo, deslize o seu dedo para o topo do ecrã e largue-o sobre o caixote "Desinstalar".

**Painel tátil:** A partir do ecrã "All Apps" (Todas as aplicações), selecione o item com o cursor e mantenha o botão do painel tátil premido. Mantendo o botão do painel tátil premido, utilize o





painel tátil para arrastar o item até ao topo do ecrã, depois solte-o por cima do ícone de Lixo.

### **Criar pastas de aplicações:**

Largue o ícone de uma aplicação sobre outro num ecrã inicial e os dois ícones ficarão combinados.

### **Widgets:**

Toque no ícone "Todas as aplicações" no seu ecrã inicial. Toque em "Widgets" no topo do ecrã. A partir do ecrã "Widgets principal", pode movimentar os widgets da mesma forma que o faz com os ícones das aplicações.

### **Alterar a imagem de fundo:**

Mantenha o dedo no ecrã sobre uma localização vazia, em seguida seleccione a partir da lista.

**Painel tátil:** Mantenha o botão do painel tátil premido num espaço vazio do ecrã principal.

### **Bloquear o ecrã tátil:**

A partir do painel de definições rápidas na barra do estado, toque nas "Definições". Desloque para baixo e toque em "Segurança". Toque em "Bloquear ecrã". Toque no tipo de bloqueio que pretende utilizar. Depois de definir aqui um bloqueio, será apresentado um ecrã de bloqueio sempre que activar o ecrã, a solicitar o padrão, o PIN ou outra chave especificada.

### **Para abrir a aplicação ARCHOS Music**

Mantenha o botão Tocar/Pausa no teclado premido durante alguns segundos.



# Resolução de problemas

## **Se o aparelho bloquear:**

Prima o botão LIGAR/DESLIGAR durante 10 segundos ou utilize a opção Reiniciar o hardware. Para utilizar a opção Reiniciar o hardware, prima o botão "orifício de reinício" utilizando um objecto pontiagudo, como um palito.

## **Se o seu aparelho não ligar:**

1. Carregue o aparelho.
2. Prima o botão LIGAR/DESLIGAR durante 10 segundos ou utilize a opção Reiniciar o hardware.

## **Se pretender aumentar a autonomia da bateria:**

Diminua o brilho do ecrã e desligue as ligações sem fios, se não estiverem a ser utilizadas.

## **Se o funcionamento do aparelho for demasiado lento:**

Encerre todas as aplicações que não estejam a ser utilizadas.

## **Se a recepção WiFi for demasiado lenta:**

Certifique-se de que não está afastado do ponto de ligação WiFi.

Atualizar o firmware do dispositivo: <http://www.archos.com/support>.

Redefinir as configurações de sua conexão.

Contacte a sua operadora da ligação WiFi.

## **Se quiser restaurar o seu produto (Esqueceu-se da sua palavra-passe? Apagou todas as suas definições?):**

1. Insira um clipe de papel no botão Recovery do produto.
2. Mantenha o clipe de papel no botão Recovery do produto e conecte o cabo de alimentação à ARCHOS.



# Содержание

Содержимое упаковки .....	142
Начало работы.....	143
Описание устройства.....	144
Подключение к сети Wi-Fi.....	146
Интерфейс Android™ .....	148
Archos Mapping Tool.....	152
Знакомство с Android™ .....	158
Устранение неполадок.....	160

RU

За дополнительной информацией обратитесь к разделу часто задаваемых вопросов и руководству пользователя для Вашего устройства на сайте [www.archos.com](http://www.archos.com). Обязательно прочтите их прежде, чем задумываться о возврате устройства. Ваша проблема может оказаться не столь уж значительной. Мы часто обновляем и улучшаем свою продукцию, поэтому графический интерфейс или функциональность программного обеспечения Вашего устройства могут несколько отличаться от представленных в настоящем Кратком руководстве пользователя.

# Содержимое упаковки

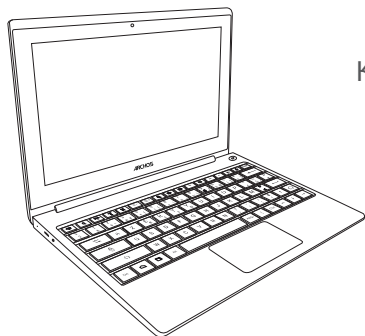

ARCHOS ArcBOOK



Краткое руководство  
Гарантии и инструкции  
по безопасности



Кабель USB

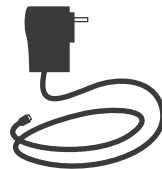

Зарядное устройство

# Начало работы

## Зарядка

Для зарядки устройства подключите кабель электропитания к разъему питания.

Устройство ARCHOS включится и начнет заряжаться.

Индикатор зарядки горит красным при зарядке батареи.

После завершения зарядки загорается голубой индикатор.

<b>Если устройство выключено</b>	Для включения устройства нажмите кнопку включения/выключения.
<b>Если устройство включено</b>	<ul style="list-style-type: none"><li>- При коротком нажатии кнопки включения/выключения устройство перейдет в режим ожидания.</li><li>- При длительном нажатии кнопки включения/выключения будет выведено меню. Для отключения устройства выберите соответствующую команду.</li></ul>

### **СОВЕТ:**

Вы можете пользоваться устройством ARCHOS во время зарядки. Перед первым использование устройство должно полностью зарядиться. Разрешается использовать только зарядное устройство из комплекта поставки.

Зарегистрируйте свое изделие, чтобы получать обслуживание в более полном объеме.

При работе с компьютером перейдите по ссылке [www.archos.com/register](http://www.archos.com/register).



# Описание устройства

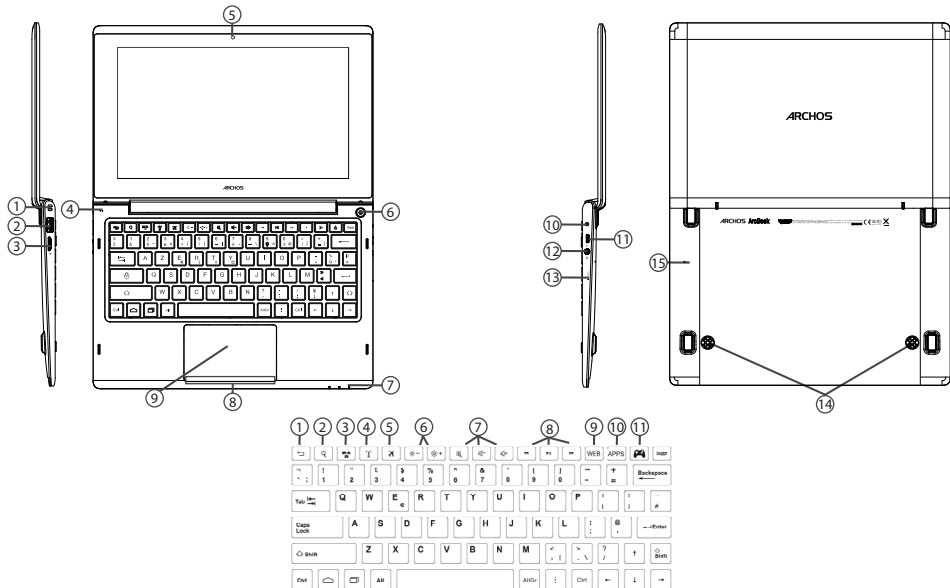





## Разъемы устройства

- |  |                               |                         |
|--|-------------------------------|-------------------------|
| 1 Разъем для подключения замка Кенсингтона | 6 Кнопка включения/выключения | 11 Порт Micro-USB       |
| 2 USB-порт                                 | 7 Индикатор зарядки           | 12 Гнездо для наушников |
| 3 Разъем для карты Micro-SD                | 8 Кнопка сенсорной панели     | 13 кнопку Восстановить  |
| 4 Микрофон                                 | 9 Сенсорная панель            | 14 Акустическая система |
| 5 Веб-камера                               | 10 Разъем питания             | 15 Кнопка перезапуска   |

RU

## Кнопки быстрого вызова команд

- |                      |  |                       |
|----------------------|--|-----------------------|
| 1 Кнопка возврата    | 5 Кнопка перехода в режим «В самолете»         | 9 Кнопка вызова WEB   |
| 2 Кнопка поиска      | 6 Кнопки регулировки яркости                   | 10 Кнопка вызова APPS |
| 3 Кнопка уведомлений | 7 Кнопки регулировки громкости                 |                       |
| 4 Кнопка WiFi        | 8 Кнопки вызова музыкального приложения ARCHOS |                       |

# Подключение к сети Wi-Fi

ВНИМАНИЕ: Убедитесь, что Вы находитесь в зоне покрытия Wi-Fi.

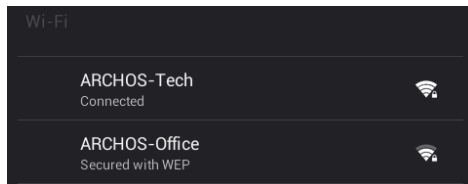



- 1 Коснитесь и удерживайте значки времени и аккумулятора, чтобы открыть строку состояния. Отобразится синяя линия.
- 2 Потяните синюю линию вниз, чтобы отобразить панель мониторинга состояния.
- 3 Коснитесь пункта «WiFi off [WiFi выкл.]» на панели мониторинга состояния. Отобразится страница WiFi.
- 4 Если связь Wi-Fi выключена, переместите переключатель WiFi в положение ON (ВКЛ).
- 5 После включения устройство ARCHOS выполнит поиск доступных сетей Wi-Fi. Выберите ту сеть, к которой хотите подключиться. Частные сети отображаются в виде значка с замком, и для них потребуется ввести пароль.

## Быстрое подключение

Вы можете подключить вашу сеть WiFi через мастер настройки безопасного подключения WiFi.

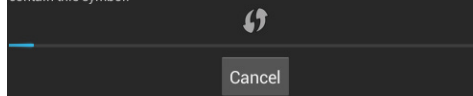
Press the WiFi Protected Setup button on your router. It may be called "WPS" or contain this symbol:



- 1 Нажмите кнопку WiFi Protected Setup  в разделе Settings > Wireless & networks (Настройки > Беспроводные и проводные сети).
- 2 На вашем Интернет-роутере нажмите кнопку WiFi Protected Setup, так называемую WPS, или содержащую символ .

### СОВЕТЫ:

- При наборе пароля сети WiFi советуем включать «Show password» (Отображение пароля), чтобы вы могли видеть набираемые символы. Для получения пароля сети WiFi (или ее настроек), обратитесь к провайдеру этой сети WiFi. Если ваша сеть WiFi включена и вы находитесь в зоне покрытия сети, к которой уже подключились, ваш ARCHOS постарается подключиться к ней автоматически.
- Для включения режима удержания WiFi-подключения, даже когда устройство переходит в спящий режим, нажмите значок Menu (Меню) на странице «WiFi». Затем, выберите Advanced > Keep WiFi on during sleep > Always (Дополнительные настройки > Удерживать WiFi включенным в режиме сна > Всегда).

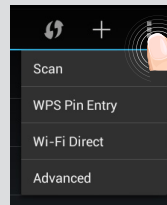

RU

# Интерфейс Android™





- ① **Пиктограммы приложений Android™**  
> Прикоснитесь к пиктограмме для запуска приложения.
- ② **Постоянные ярлыки приложений Android™**
- ③ **Кнопка «Назад»**
- ④ **Кнопка «Домой»**
- ⑤ **Кнопки последних приложений**
- ⑥ **ARCHOS mapping tool**
- ⑦ **Кнопка «Все приложения»**  
> Прикоснитесь к этой пиктограмме, чтобы отобразить все приложения и виджеты, установленные в Вашем ARCHOS. Здесь находятся все загруженные Вами приложения.
- ⑧ **Поиск Google™**  
> Прикоснитесь к позиции «Google», чтобы выполнить тестовый поиск, или к пиктограмме микрофона, чтобы выполнить голосовой поиск.
- ⑨ **Строка состояния**  
> Отображаются сообщения и быстрые настройки.

# Интерфейс Android™

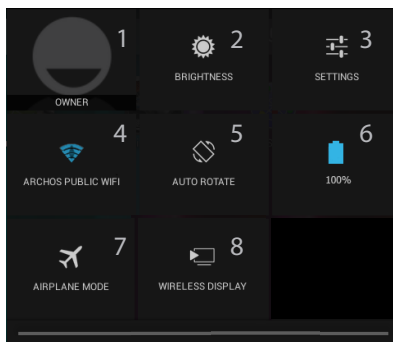

## 3:18 Быстрые настройки

- 1 Текущий пользователь<sup>(1)</sup>
- 2 Регулировка яркости экрана.
- 3 Доступ ко всем настройкам.
- 4 Включение/выключение соединения Wi-Fi.
- 5 Активация/деактивация автоматической ориентации экрана при повороте устройства ARCHOS.
- 6 Процентная величина остатка заряда аккумулятора
- 7 Активация/деактивация всех беспроводных соединений, в частности, во время авиаперелета.
- 8 Включение беспроводной передачи данных.<sup>(2)</sup>

<sup>(1)</sup>Новая многопользовательская поддержка для планшетов предоставляет различным пользователям свое собственное отдельное, конфигурируемое место на одном устройстве. Добавьте пользователей в Settings > Device [Настройки > Устройство].

<sup>(2)</sup>Вы можете смотреть фильмы, видеоролики YouTube и все, что находится на вашем экране, на телевизоре высокой четкости. Чтобы быстро и легко отобразить то, что находится на вашем экране, нужно подключить адаптер беспроводной передачи данных к любому телевизору с мультимедийным интерфейсом высокой четкости (HDMI).

## Последние приложения

Открывается список эскизов приложений, с которыми Вы недавно работали:



**Коснитесь:** , чтобы открыть приложение.

**Удержание:** отображение параметров

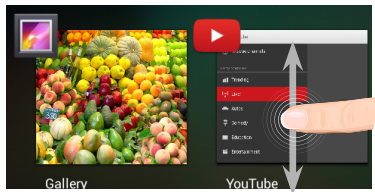

**Прокрутка вверх или вниз:** закрытие приложения.

RU

# ARCHOS mapping tool

Утилита ARCHOS для сопоставления кнопок — это приложение, установленное в устройстве ArcBook. Она позволяет задать связь между виртуальными средствами управления, имеющимися в игре, и физическими средствами управления устройством ArcBook, используя для этого средства сопоставления.



физические  
средства  
управления

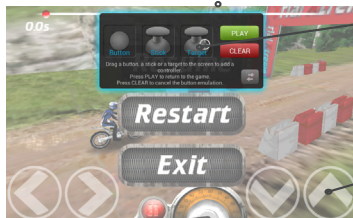

средства  
сопоставления

виртуальные  
средства  
управления

## Подсказка 1

В утилите ARCHOS для сопоставления кнопок уже заготовлены профили для более чем 100 игр. Кроме того, многие игры функционируют автоматически с помощью физических кнопок.

## Подсказка 2

При запуске игры с сопоставленными виртуальными средствами управления автоматически выбирается правый профиль сопоставления вне зависимости от того.



## Запуск утилиты ARCHOS для сопоставления функций с кнопками

1. Запустите игру.

Когда отобразится начальный экран, отобразятся виртуальные средства управления.

2. На системной панели выберите пиктограмму утилиты ARCHOS для сопоставления функций с кнопками.



Пиктограмма утилиты ARCHOS для сопоставления функций с кнопками

Дополнительный экран сопоставления отобразится вместе с интерфейсом утилиты для сопоставления функций с кнопками.



### Интерфейс утилиты ARCHOS для сопоставления функций с кнопками

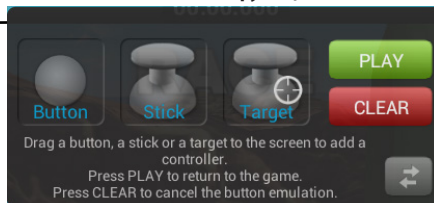

# ARCHOS mapping tool

## Задание положения средств сопоставления

Удерживая средство сопоставления нужного типа, перетащите его на нужную кнопку виртуального управления.

Имеется три типа средств сопоставления



**Кнопка**  
Это средство сопоставления предназначено для кнопки крестовины выбора направления движения кнопок X, Y, B, A, а также для кнопок L1, R1, L2, R2, Start, Select



**Джойстик**  
Это средство сопоставления предназначено для аналогового джойстика направления.



**Цель**  
Это средство сопоставления предназначено для джойстика прицеливания. Как правило, в играх-стрелялках он размещается в центре экрана.

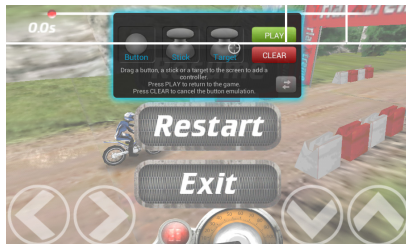



## Задание связи между средством сопоставления и физическим средством управления

1. При совмещении средства сопоставления с виртуальным средством управления предлагается выбрать требуемое физическое средство управления, которое будет сопоставлено с виртуальным.

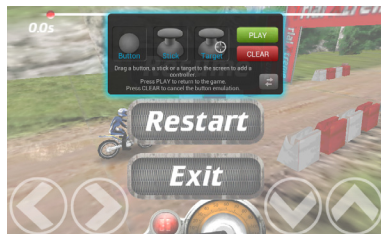

2. Как только будет установлена связь между физическим средством управления и средством сопоставления, сразу же наименование физического средства управления отобразится на средстве сопоставления.



RU



# ARCHOS mapping tool

## Масштабирование средств сопоставления

Размер некоторых виртуальных средств управления больше размера средств сопоставления.

1. Изменять размер вместе с правого аналогового джойстика.
2. Нажмите на кнопку для подтверждения.

Увеличить можно только средства сопоставления «Джойстик» и «Цель».

## Сохранение параметров

После завершения сопоставления физических и виртуальных средств управления, выберите Play (Играть)  для подтверждения. Профиль будет сохранен и связан с этой игрой.

Дополнительный экран сопоставления исчезнет, и вы можете начинать игру.

Всякий раз, когда вы начинаете игру, вы сообщили, что эмуляции виртуального управления работает. Каждое сопоставление обладает специфичными свойствами для каждой отдельной игры.

Нажмите на предупреждении, чтобы показать профиль сопоставления игры. Вы можете изменить или удалить его.



## Вопросы и ответы о сопоставлении

Что делать, если после совмещения средства сопоставления с виртуальным средством управления не появляется ни один вариант выбора?

1. Нажмите параметрическим управлением Расположение.

Отобразится меню

2. Выберите пиктограмму  для назначения средства сопоставления.

Хотите удалить ранее настроенное средство сопоставления?

1. Нажмите параметрическим управлением Расположение.

Отобразится меню

2. Выберите пиктограмму  для удаления средства сопоставления.

Хотите удалить профиль сопоставления, настроенный для данной игры?

1. В интерфейсе игры, выберите значок отображения инструмента.

2. В утилите ARCHOS для сопоставление кнопок выберите Clear (Очистить).

3. Для подтверждения нажмите OK.

## Отображение возможных действий

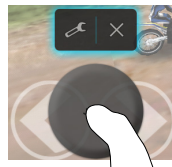

## Удаление профиля сопоставления

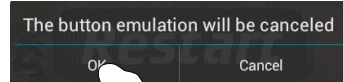
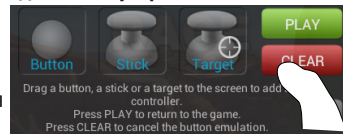

RU



# Знакомство с Android™

---

## Использование сенсорной панели

Чтобы выполнить короткое нажатие, коснитесь сенсорной панели один раз.

Чтобы выполнить длительное нажатие, удерживайте кнопку сенсорной панели.

## Расширенный домашний экран:

Выполняйте переходы между различными панелями домашнего экрана, смещая их влево и вправо.

**Сенсорная панель:** удерживайте кнопку сенсорной панели и одновременно перемещайте курсор с помощью сенсорной панели.

## Перемещение элемента домашнего экрана:

Выберите необходимый элемент и удерживайте палец, пока не появится сетка позиционирования, затем переместите его в требуемое положение, и отпустите палец.

**Сенсорная панель:** Наведите курсор на требуемый объект и удерживайте кнопку сенсорной панели. Одновременно удерживайте кнопку сенсорной панели и выполняйте перемещение объекта с помощью сенсорной панели.

## Удаление элемента домашнего экрана:

Выберите необходимый элемент и удерживая палец, проведите его к верхней части экрана и поместите его в корзину Remove (удалить).

**Сенсорная панель:** Наведите курсор на объект и удерживайте кнопку сенсорной панели. Удерживая кнопку сенсорной панели, с помощью сенсорной панели переместите объект поверх экрана и перенесите его на значок удаления (Remove)X.

## Удаление элемента:

Выберите необходимый элемент на экране «Все приложения» и удерживая палец, проведите его к верхней части экрана и поместите его в корзину Uninstall (удалить).

**Сенсорная панель:** На экранах всех приложений (“All apps”) выберите объект курсором



и удерживайте кнопку сенсорной панели. Удерживая кнопку сенсорной панели, с помощью сенсорной панели переместите объект поверх экрана и перенесите его на значок корзины.

### **Создание папок приложений:**

Поместите ярлык одного приложения поверх другого на домашнем экране, и два ярлыка объединятся.

### **Виджеты:**

Выберите значок «Все приложения» на домашнем экране. Нажмите на Widgets в верхней части экрана. На основном экране Widgets можно переставлять виджеты таким же образом, как и ярлыки приложений.

### **Изменение обоев:**

Удерживайте палец на свободном месте домашнего экрана, затем выберите обои из списка.

**Сенсорная панель:** Выбрав свободное место на главном экране, удерживайте кнопку сенсорной панели.

### **Блокировка сенсорного экрана:**

Нажмите на Settings (настройки) на панели быстрых настроек в строке состояния. На экране Settings выполните прокрутку вниз и нажмите на значок Security (защита). Нажмите на значок Screen lock (блокировка экрана). Выберите тип блокировки, который хотите использовать. После того, как будет установлена блокировка, при каждом включении экрана будет отображаться экран блокировки с запросом на ввод комбинации символов, PIN-кода или иного указанного ключа.

### **Запуск музыкального приложения ARCHOS**

Выполните длительное нажатие кнопки быстрого вызова команды воспроизведения/паузы на клавиатуре.



# Устранение неполадок

## **В случае зависания планшета:**

Нажмите на кнопку ВКЛ/ВЫКЛ и удерживайте в течение 10 секунд.

## **Если устройство не включается:**

1. Зарядите устройство.
2. Нажмите на кнопку ВКЛ/ВЫКЛ и удерживайте в течение 10 секунд.

## **Если Вы хотите продлить срок работы батареи:**

Уменьшите яркость экрана и выключите беспроводные соединения, если они не используются.

## **Если устройство функционирует слишком медленно:**

Закройте все приложения, которые в данный момент не используются.

## **Если принимаемый сигнал Wi-Fi слишком слаб:**

Убедитесь, что не находитесь слишком далеко от узла доступа Wi-Fi.

## **Обновите встроенную микропрограмму устройства:**

<http://www.archos.com/support>.

Сбросьте и повторно введите параметры соединения.

Обратитесь к провайдеру сети Wi-Fi.

## **Если хотите восстановить состояние изделия (забыли пароль? стереть все настройки?):**

1. Вставьте скрепку в кнопку Восстановить.
2. Держите скрепку в кнопке Восстановить и подключите кабель питания к ARCHOS.









## National restrictions

This device is intended for home and office use in all EU countries (and other countries following the EU directive 1999/5/EC) without any limitation except for the countries mentioned below:

Country	Restriction	Reason/remark
Bulgaria	None	General authorization required for outdoor use and public service
France	Outdoor use limited to 10 mW e.i.r.p. within the band 2454-2483.5 MHz	Military Radiolocation use. Refarming of the 2.4 GHz band has been ongoing in recent years to allow current relaxed regulation. Full implementation planned 2012
Italy	None	If used outside of own premises, general authorization is required.
Luxembourg	None	General authorization required for network and service supply (not for spectrum)
Norway	Implemented	This subsection does not apply for the geographical area within a radius of 20 km from the centre of Ny-Alesund
Russian Federation	None	Only for indoor applications



Note: Frequency 2454-2483.5MHz are restricted to indoor use in France.

Consult the declaration of conformity on [http://www.archos.com/products/declaration\\_conformity.html](http://www.archos.com/products/declaration_conformity.html)



## Open Source Software Offer

The software bundled with this product includes software files subject to certain open source license requirements. Such open source software files are subject solely to the terms of the relevant open source software license. Such open source software is provided on an “AS IS” basis to the maximum extent permitted by applicable law.

For the open source files contained herein, please access “Open source license” section located at: Settings>About tablet\Legal information on the device for the relevant copyright and licensing terms. You may obtain a copy of Apache License, Version 2.0 at <http://www.apache.org/licenses/LICENSE-2.0>. You may also obtain a copy of GNU General Public License, Version 2 at the Free Software Foundation, INC, 51 Franklin Street, Fifth Floor, Boston, MA 02110-1301, USA.

Until the date that is three years after our last shipment of this product, you may obtain a copy of the source code corresponding to the binaries for any GPL-Licensed file by contacting ARCHOS customer service at <http://www.archos.com> and ARCHOS will send you a link to such source code or will provide instructions to get the source on a physical medium.

This offer is valid to anyone in receipt of this information.

Archos company declares that this device is in compliance with the essential requirements and other relevant provisions of Directive 1999/5/EC

# CE 1622

