



ARCHOS TV⁺

ENGLISH USER MANUAL **Version 1.0**

Please visit www.archos.com/manuals to download the latest version of this manual.

Dear Customer,

Thank you for choosing this ARCHOS product. We hope that you will enjoy using it and that it will give you satisfaction for many years to come.

Please do register your product on our website (www.archos.com/register) to ensure that you get access to our help line, to the ARCHOS Content Portal, and the TV Program Guide.

Wishing you the best multimedia experience,

The ARCHOS Team.

All the information contained in this manual was correct at the time of publication. However, as we are often updating and improving our products, your device's software may have a slightly different appearance or modified functionality than presented in this manual.

TABLE OF CONTENTS

STARTING UP.....	4
DESCRIPTION OF THE ARCHOS DEVICE.....	4
CONNECTING THE ARCHOS TO YOUR TV.....	7
THE INSTALLATION WIZARD.....	9
TURNING THE ARCHOS ON/OFF.....	9
USING THE ARCHOS INTERFACE.....	10
PRODUCT CARE.....	11
1. PLAYING VIDEO.....	12
1.1 BROWSING THROUGH YOUR VIDEOS.....	12
1.2 VIDEO PLAYBACK.....	13
1.3 VIDEO PLAYER SETTINGS.....	15
1.4 RECORDING VIDEO.....	16
1.5 PLAYING YOUR PC'S SHARED VIDEOS.....	16
2. PLAYING MUSIC.....	17
2.1 BROWSING THROUGH YOUR MUSIC FILES.....	17
2.2 MUSIC PLAYBACK.....	18
2.3 MUSIC PLAYER SETTINGS.....	20
2.4 PLAYLISTS.....	22
2.5 RECORDING ANALOGUE AUDIO.....	24
2.6 PLAYING YOUR PC'S SHARED MUSIC.....	24
3. VIEWING PHOTOS.....	26
3.1 BROWSING THROUGH YOUR PHOTOS.....	26
3.2 PHOTO VIEWER.....	27
3.3 PHOTO VIEWER SETTINGS.....	29
3.4 PLAYING A SLIDESHOW.....	29
3.5 VIEWING PHOTOS WHILE LISTENING TO MUSIC.....	30
3.6 PLAYING YOUR PC'S SHARED PHOTOS.....	30
4. USING THE FILE BROWSER.....	31
4.1 NAVIGATION.....	31
4.2 USING THE FILE BROWSER WHILE LISTENING TO MUSIC.....	33
4.3 USING THE PDF READER.....	33
5. USING THE WIFI FEATURES.....	35
5.1 BROWSING THE WEB.....	35
5.2 PLAYING YOUR PC'S SHARED MEDIA FILES.....	37
5.3 THE ARCHOS CONTENT PORTAL.....	39

TABLE OF CONTENTS CONTINUED ON NEXT PAGE...

6. TRANSFERRING FILES.....	41
6.1 USB HOST CONNECTION	41
6.2 BROWSING OTHER COMPUTERS ON THE NETWORK	42
6.3 CONNECTING THE ARCHOS TO A COMPUTER	43
7. MAIN SETTINGS.....	46
7.1 “SOUND” SETTINGS	46
7.2 “TV SETTINGS”	47
7.3 “APPEARANCE” SETTINGS.....	48
7.4 “NETWORK” SETTINGS	49
7.5 “LANGUAGE AND REGION” SETTINGS	52
7.6 “TV CONTROL” SETTINGS	53
7.7 “CLOCK” SETTINGS	53
7.8 “FIRMWARE AND PLUG-INS” SETTINGS	54
7.9 UPDATING THE FIRMWARE	54
7.10 “SYSTEM” SETTINGS	55
8. TV RECORDING: HARDWARE SETUP	58
8.1 CONNECTION PRINCIPLES	58
8.2 CONNECTING A TUNER TO YOUR ARCHOS.....	58
8.3 CONNECTING WITH A TV ONLY (NO EXTERNAL TUNER)	61
9. THE TV PROGRAM GUIDE.....	62
9.1 WHAT’S REQUIRED TO USE THIS FUNCTION?	62
9.2 ACTIVATING THE TV PROGRAM GUIDE ONLINE	62
9.3 TRANSFERRING THE PROGRAM DATA TO THE ARCHOS	63
9.4 CONFIGURING THE TV CONTROL SETTINGS	63
9.5 SCHEDULING YOUR RECORDING	66
10. OTHER RECORDING FUNCTIONS.....	68
10.1 THE “TV SCHEDULER”	68
10.2 RECORDING VIDEO MANUALLY	68
10.3 RECORDING AUDIO MANUALLY	70
10.4 EDITING YOUR RECORDINGS	71
TROUBLESHOOTING	74
RESTARTING / RESETTING YOUR ARCHOS	74
SYSTEM RECOVERY	74
REPAIR AND FORMATTING TOOLS.....	75
TECHNICAL SPECIFICATIONS.....	77
TECHNICAL SUPPORT INFORMATION	79

STARTING UP

DESCRIPTION OF THE ARCHOS DEVICE

LED INDICATORS



The LED indicators are located on the front of the device, on the left side:

Red light:

- light on: the ARCHOS is in standby mode.
- flashing: the ARCHOS is starting.

Green light:

- light on: the ARCHOS is on.

CONNECTORS

On the right side of the device:



1.	<i>USB A Connector (for USB Host) to connect a compatible USB device such as a USB Flash key, a digital camera or a portable media player.</i>
2.	<i>USB B Connector (with optional cable): to connect the ARCHOS to a computer.</i>

See Transferring Files to learn how to transfer files to/from another USB device.

On the back of the device:

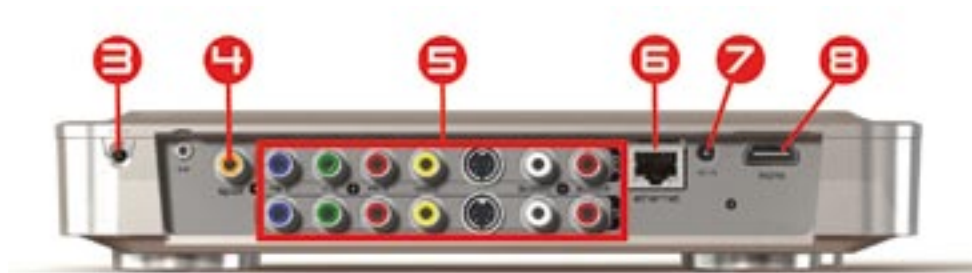

3.	<p>Reset button: ONLY use this button if you need to restart the Installation Wizard. When you press this button, the ARCHOS will restart and a message will pop up to confirm the relaunch of the wizard. If you do not respond within 10 seconds, the wizard will be automatically relaunched. See: The Installation Wizard.</p> <p>ATTENTION: if you use the reset button and relaunch the wizard, no data will be erased but your TV connection settings will be lost, and you will have to set them up again through the wizard.</p>
4.	<p>SPDIF Out*: to connect to an amplifier that has an SPDIF audio input (such as a 'home cinema').</p>
5.	<p>Audio/Video inputs and outputs: to connect to the Audio and Video connectors of your TV (and tuner), using the supplied cables. Audio/Video inputs and outputs available: RGB**, Component (YPbPr)*, Composite Video**, S-Video***, Stereo Analog Audio.</p> <p>Check the manual of your TV (and tuner) to see what types of connectors your device has.</p>
6.	<p>Ethernet connector*: you can plug an Ethernet cable to connect to the Internet and to your local network.</p>
7.	<p>DC in: to connect the included power adapter.</p> <p>In the event that your ARCHOS freezes or does not respond anymore, disconnect the power adapter, wait for 15 seconds and reconnect it. When the red LED indicator stops blinking, press the Power button on the supplied remote control to turn on your device.</p>
8.	<p>HDMI Out*: to connect to a television that has an HDMI input (such as an 'HD Ready' TV).</p>

* requires optional cable(s)

** US: requires optional cable(s)



*** Europe: requires optional cable(s)



THE REMOTE CONTROL







- You will need the remote control in order to control your ARCHOS TV+.
- Your ARCHOS device has an infrared receiver located on the front of the device, on the left side (next to the LED indicators). Point the supplied remote control towards the infrared receiver.





1.	<i>This part of the remote control is used for the Web Browser.</i>	
		Use the direction pad to move the cursor that appears on the screen.
		Pressing this button will activate 2 modes at the same time: <ul style="list-style-type: none"> - the "left button lock" mode: the direction pad will act as if you moved a mouse while holding its left button at the same time. It will allow you, for example, to use sliders or other dragging controls. - the navigation buttons, at the top right, will allow you to move from one link/field to another (normally they scroll the page up/down). Press again to disable these 2 modes.
L		This button is like a mouse's left button. Depending on where you are in the interface, it will allow you to open a link, execute a function, etc.
R		This button is like a mouse's right button. Depending on where you are in the interface, pressing this button will display a contextual menu.

2.	<i>These are the main buttons:</i>	
		Navigation buttons: move from one item to another
OK		Enter/Accept or Play/Pause/Resume
X		Exit button: Escape/Back/Stop
		Up Accelerator button: High-speed fast forward, list scrolling or zoom in

	Down Accelerator button: High-speed fast rewind, list scrolling or zoom out
M	Menu button: Display a text description of the available menu icons
TV	Switch the display of the image between the ARCHOS and a tuner (not in HDMI output mode), if you have connected one to the ARCHOS' input connectors. See <i>TV Recording: Hardware Setup</i> .
	Power button: Turn the ARCHOS on/off
+ -	Volume buttons: Increase/decrease volume
	Mute sound
	Tab button: Tab between available screens

3. *The keyboard can be used to enter a Web address, write an e-mail, name/re-name a folder, etc:*

	Caps Lock key
Alt	Green Alt key: enable the keys' green secondary functions
Alt	Blue Alt key: enable the keys' blue secondary functions
	Shift key
	delete character before cursor

In order to type one of the green/blue secondary characters in capital letters (é, è, ç, etc.), press Caps Lock, then Alt green/blue, and press the corresponding key.

CONNECTING THE ARCHOS TO YOUR TV

Connection Diagram for Europe:

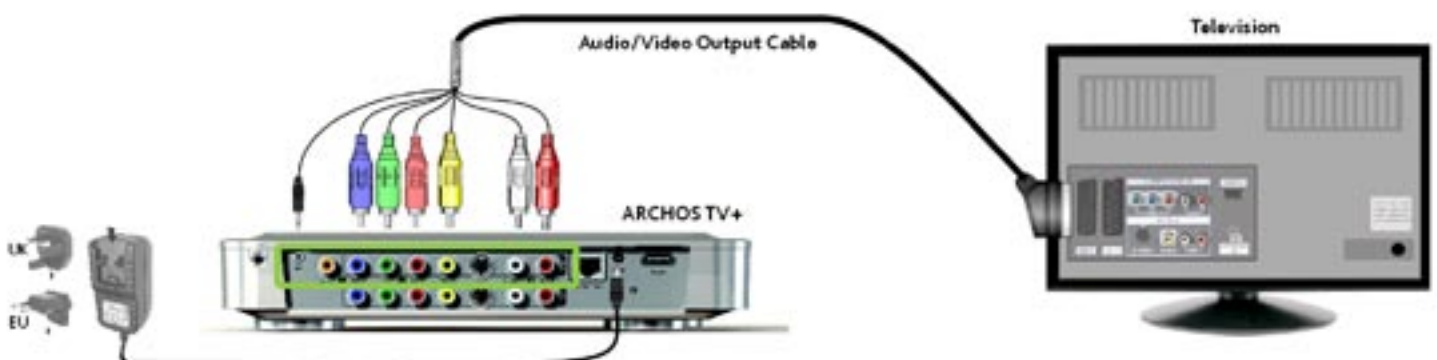

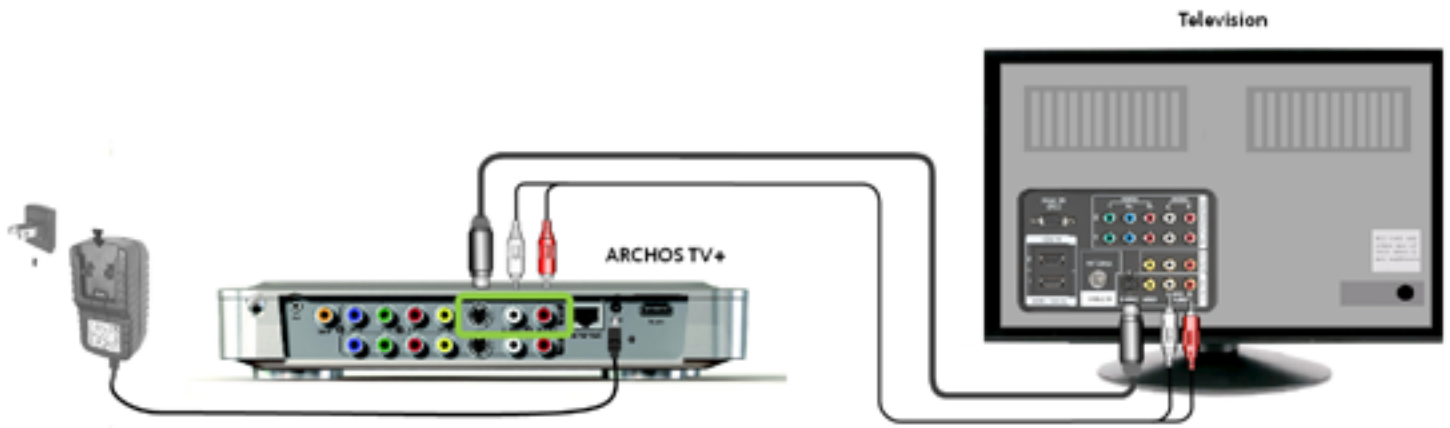
Connection Diagram for North America: *

** North America: If your TV does not have an S-video input connector, use a standard male/male RCA cable (on the yellow video jack) instead of the supplied S-video cable.*

1. Connect the ARCHOS' outputs to your TV's inputs as shown above. If you have an HDMI cable, you can connect it now.
 2. Connect the included power adapter to the jack labeled **DC-IN** on the back of the ARCHOS.
 3. Then plug the other end of the power adapter into an available wall socket.
- ✓ The first time you connect the power adapter, the ARCHOS will start automatically. The red LED indicator will start blinking while the device is starting. When the ARCHOS is on, the green LED will light up.

Use only the supplied ARCHOS power adapter as other adapters may damage this device (even if they give the same voltage rating).

4. Make sure that your TV is switched to the AV input which the ARCHOS is connected to (on the back of the TV).
5. Once the ARCHOS turns on (green light), your device will cycle between three different video output modes in order for you to select the correct one. Wait until you see an image in color on your TV (this may take up to 30 seconds), and press **OK** on the remote control.
6. Then follow the on-screen instructions (Installation Wizard) to finish installing the ARCHOS.

See TV Recording: Hardware Setup to learn how to connect a tuner to the ARCHOS in order to schedule a TV recording (manually or via the TV Program Guide).

THE INSTALLATION WIZARD

- The Installation Wizard will help you configure the main functions of the ARCHOS.
- If you ever need to relaunch the Installation Wizard, press the reset button. The ARCHOS will restart and a message will pop up to confirm the relaunch of the wizard. If you do not respond within 10 seconds, the wizard will be automatically relaunched.

ATTENTION: if you use the reset button and relaunch the wizard, no data will be erased but your TV connection settings will be lost, and you will have to set them up again through the wizard.

NAVIGATING INSIDE THE WIZARD

- In the different screens of the wizard, use the up/down navigation buttons on the remote control to highlight a parameter.
- Use the left/right buttons to select a different setting for a parameter.
- When you have finished adjusting your settings, use the navigation buttons to highlight “**Next**” and press **OK** on the remote control to move on to the next screen.
- If you want to go back to a previous screen, select “**Previous**”.

CONFIGURING THE WIFI/ETHERNET CONNECTION

- At the end of the Installation Wizard, in the “**Network**” screen, you are invited to configure your WiFi/Ethernet connection.
- Choose “**WiFi**”, “**Ethernet Cable**” (standard Ethernet cable not supplied) or “**None**”, based on the way you want to connect to the Internet (or local network). If you do not have access to the Internet, select “**None**”.
- See “*Network*” Settings.

TURNING THE ARCHOS ON/OFF



- Press the Power button  on the remote control to turn on your ARCHOS or put it into standby mode.
- The green LED indicator, on the front of the device, lights up when the device is on. The red LED lights up when the device is in standby mode.

In the event that your ARCHOS freezes or does not respond anymore, disconnect the power adapter, wait for 15 seconds and reconnect it. When the red LED indicator stops blinking, press the Power button on the supplied remote control to turn on your device.

USING THE ARCHOS INTERFACE

INTERFACE DESCRIPTION

Status Bar

- In the top right corner of the screen, the status bar indicates the 'network connection' status (WiFi or Ethernet), the volume level and the current time of your device.



Tabs

- In the top left corner of the screen, the tabs area shows other available applications and screens. They vary, depending on where you are in the interface.
- When there is only one tab available, the Tab icon in the top left corner is grayed out.

Contextual Menu

- In the lower right corner of the screen, the contextual menu area shows the menu icons. The available options will vary, depending on where you are in the interface.
- In the Home screen, choose the "**Settings**" menu item to access the main settings of your ARCHOS.
- In the Home screen, the "**Resume**" menu item allows you to resume the last-played music or video file, if it was interrupted before the end. If the "**Resume**" menu icon does not appear, it means that no music or video file playback can be resumed.



Home Screen

- This is the main screen of your ARCHOS, showing its main functions.

Main Button Actions:

- To open an application/screen via its icon or item, use the Navigation buttons to highlight the icon/item and press **OK**.
- In the different applications, you can go back one level in the hierarchy by pressing the Exit button **X** once. Wherever you are in the hierarchy, you can go back directly to the Home screen by holding the Exit button.
- When several tabs are available, you can switch between them by pressing the Tab button .
- To execute a menu icon's function, press the Menu button **M**, select a menu item with the navigation buttons, and press **OK**.
- While playing a video, song or photo slideshow, you can pause/resume it by pressing **OK**.

Other Button Actions



- When watching a video or listening to music, you can hold the left/right Navigation buttons to move the cursor in the progression bar to another location in the video or song.
- To increase/decrease volume, use the Volume buttons (**+/-**).
- In the different browsers (File, Music, Video, Photo), you can hold the up/down Navigation buttons to scroll the file list up and down. You can also scroll faster by using the Accelerator buttons.
- In the Web browser and the PDF viewer, you can scroll up and down by holding the up/down Navigation buttons.

PRODUCT CARE

Your ARCHOS is an electronic product that needs to be treated with care:

- Do not subject it to unnecessary shock or vibration.
- Do not subject it to heat, keep it ventilated (especially when connected to a computer).
- Keep it away from water and excessively humid areas.
- Keep it away from high electromagnetic fields.
- Do not open it up. There are no user-serviceable parts inside. Opening will void your warranty.

1. PLAYING VIDEO



In the Home screen, select the **“Video”** icon to enter the Video mode.

1.1 BROWSING THROUGH YOUR VIDEOS

- The **“Video”** browser allows you to navigate through the **Video** folder of the ARCHOS' hard drive.
- You can go back one level in the hierarchy by closing the current screen (Exit button **X**). Wherever you are in the hierarchy, you can go back directly to the Home screen by pressing and holding down on the Exit button.

THE VIDEO BROWSER

- The first screen of the Video mode shows you all the videos and subfolders located in the **Video** folder.
- To play a video, highlight it, then press **OK**.
- If a video is in a subfolder of the **Video** folder, open the subfolder, and you will see your video.



- *In the “Video” browser, each video file appears with a thumbnail, displayed on the left of the file’s name.*
- *To define a new thumbnail for a video file, open the video, select the “Set” menu item, and choose “Thumbnail” (see: Video Playback Menu Items).*

VIDEO BROWSER MENU ITEMS

“Info”



- displays a message box with information about the highlighted video file.

“File Management”

-  - **“Rename”**: allows you to change the name of the highlighted video file using the remote control’s keyboard.
- **“Delete”**: allows you to delete the highlighted video file. A confirmation screen will pop up.

“Bookmark”

-  - **“Resume”**: will resume playing the highlighted video from the bookmark.
- **“Clear”**: will remove the bookmark from the highlighted video file.

“Bookmark” only appears in the menu when a bookmarked video file is highlighted.

“Settings”

-  - you can choose to display the Video Player settings screen (see: *Video Player Settings*) or the **“Sound”** settings screen (see: *“Sound” Settings*).

1.2 VIDEO PLAYBACK







To play a video, highlight the file and press **OK**. The menu overlay will disappear automatically after a few seconds.

VIDEO PLAYBACK SCREEN

1. Exit icon
2. video file name
3. Tab icon
4. volume level
5. video progression bar
6. menu items



VIDEO PLAYBACK BUTTON CONTROLS

	- press once: stop the video and go back to the "Video" browser - hold: exit the Video mode and go back directly to the Home screen.
	pause/resume the video
	accelerated fast forward
	left/right: fast rewind/forward
	accelerated fast rewind
	display/hide the menu overlay
M	display available menu items
+ -	increase/decrease volume
	Mute sound

VIDEO PLAYBACK MENU ITEMS

"Info"



- displays a message box with information about the current video file.

"Soundtrack" and/or "Subtitles"



- allows you to select a different audio track*.

- allows you to choose subtitles**.

** Only if the video file contains several audio tracks.*

*** Only if the subtitles are in a separate file. The supported file types are: .srt, .ssa, .sub (text based) and .smi.*

"Format"



- allows you to change the way the image is displayed.

- **"Auto"**: adjusts the video size to best adapt to the TV.

- **"Full Screen"**: enlarges the picture to fill the screen. In order to fit the screen, your device might need to cut small parts of the image, most likely at the top and bottom.

- **"Maximized"**: enlarges the picture to fill the screen, considering the image is encoded in 2.35 format with black bands at the top and bottom.

- **"Original"**: displays the entire picture in its original format.

“Speed”

-  - will play the current video in slow motion or high speed.
- while paused in slow motion, you can advance frame by frame, using the right arrow.

“Set”

-  - **“Bookmark”**: sets a bookmark at the current spot in the video. Only one bookmark per file is allowed. You can bookmark up to 32 files. Bookmarked videos will appear, in the **“Video”** browser, with a bookmark symbol and a progression bar.
- to resume playing a video from a bookmark, go to the **“Video”** browser and highlight the bookmarked video file. Select the **“Bookmark”** menu item, then choose **“Resume”** (**“Clear”** will remove the bookmark from the video).
- **“Thumbnail”**: saves the current image as a new thumbnail for this file. In the **“Video”** browser, the video’s thumbnail will be replaced by the new one.
- **“Wallpaper”**: the current image will be defined as your device’s background image.

“Settings”

-  - you can choose to display the Video Player settings screen (see next section) or the **“Sound”** settings screen (see: *“Sound” Settings*).

1.3 VIDEO PLAYER SETTINGS

- In the Video mode, you can access the Video Player settings screen by using the **“Settings”** menu item .
- Use the left/right arrows to select a different setting for a parameter.

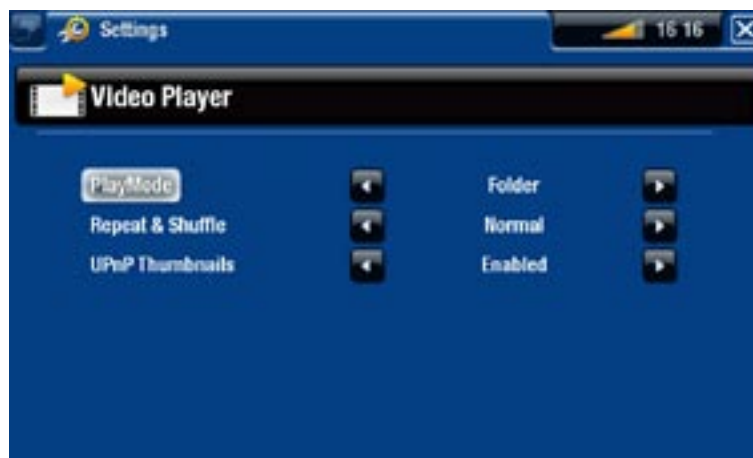

“PlayMode”, “Repeat & Shuffle”

- the following table explains how the video player will work according to the settings you chose in **“PlayMode”** AND **“Repeat & Shuffle”**.

“PlayMode”	“Repeat & Shuffle”	What the video player does...
“Single”	“Normal”	- plays the current video file and stops.
	“Repeat”	- plays the current video file repeatedly.
“Folder”	“Normal”	- plays all the video files of the current folder one after the other, and then stops.
	“Repeat”	- plays all the video files of the current folder one after the other. This will be repeated indefinitely.
	“Shuffle”	- plays all the videos of the current folder randomly.

“UPnP Thumbnails”

- here you can enable/disable the video thumbnails while browsing through your PC’s shared videos (see: *Playing your PC’s Shared Media Files*). If you choose “**Disabled**”, you will be able to browse through your PC’s shared videos faster.

1.4 RECORDING VIDEO



- Your ARCHOS gives you the possibility to record video from most any standard video source.
- See: *Recording Video Manually*.



- You will also have the possibility to schedule TV recordings easily, via the TV Program Guide (EPG).
- See: *The TV program Guide*.

1.5 PLAYING YOUR PC’S SHARED VIDEOS



- Using a WiFi or Ethernet connection, your ARCHOS gives you the possibility to watch, directly on your TV, shared videos stored in your PC’s Windows Media® Library.
- For this to work, you will need a WiFi or Ethernet connection and Windows Media® Player 11 or higher* installed on your PC.
- The ARCHOS uses the UPnP (Universal Plug-and-play) standard to play streamed videos from your PC’s Windows Media® Library.
- See: *Playing your PC’s Shared Media Files*.

* There are other products on the market that also can share media files using the UPnP standard.

2. PLAYING MUSIC



In the Home screen, select the “**Music**” icon to enter the Music mode.

2.1 BROWSING THROUGH YOUR MUSIC FILES

- There are two types of views for you to browse through your songs: the Music Library and the Music Browser.
- In both views, you can go back one level in the hierarchy by closing the current screen (Exit button **X**). Wherever you are in the hierarchy, you can go back directly to the Home screen by pressing and holding down on the Exit button.

THE MUSIC LIBRARY

- The Music Library (default view) shows your music sorted by categories (Artist, Album, Genre, etc.) if your music files contain these song information tags.
- When new music is copied to the ARCHOS, the Music Library will be updated automatically.
- If some of your music files do not contain information tags, they will be classified as (**Unknown**) in the Music Library.



THE MUSIC BROWSER

- The music browser allows you to navigate through the **Music** folder of your device's hard drive.
- To use it, select “**Hard Drive**” in the initial Music Library view.



MUSIC LIBRARY AND MUSIC BROWSER MENU ITEMS*

“Info”

 - displays a message box with information about the highlighted music file.

“Show playlist”

 - opens a playlist edition window on the right (see: *Playlists*).

“Bookmark”

 - **“Resume”**: will resume playing the highlighted song from the bookmark.
- **“Clear”**: will remove the bookmark from the highlighted music file.

“Bookmark” only appears in the menu when a bookmarked music file is highlighted.

“File Management”

 - **“Rename”**: allows you to change the name of the highlighted music file using the remote control's keyboard.
- **“Delete”**: allows you to delete the highlighted music file. A confirmation screen will pop up.

“Settings”

 - you can choose to display the Music Player settings screen (see: *Music Player Settings*) or the **“Sound”** settings screen (see: *“Sound” Settings*).

** The available menu items will vary depending on the mode you chose (Music Library or Music Browser).*

2.2 MUSIC PLAYBACK

- Use the up/down navigation buttons to browse through the list of audio tracks.
- To play a song, highlight the corresponding file and press **OK**.

MUSIC PLAYBACK SCREEN

1. Exit icon
2. artist name, album title, song title, playback status icon(s) and track number
3. available tabs
4. volume level
5. previous track
6. next track
7. progression bar
8. menu items



MUSIC PLAYBACK BUTTON CONTROLS

✕	<ul style="list-style-type: none"> - press once: stop the song and go back to the "Music" Library or browser - hold: exit the Music mode and go back directly to the Home screen.
⏸	pause/resume the song
⏩	accelerated fast forward
⏮	<p><u>left:</u></p> <ul style="list-style-type: none"> - press once: back to the beginning of the song, or previous song (in the first 10 seconds of a track) - hold: fast rewind <p><u>right:</u></p> <ul style="list-style-type: none"> - press once: next song - hold: fast forward
⏮	accelerated fast rewind
📄	tabs back to the Music Library or Music browser (depending on which mode you launched the song from)
M	display available menu items
+ -	increase/decrease volume
🔇	Mute sound

MUSIC PLAYBACK MENU ITEMS

“Info”



- displays a message box with information about the current music file.

“ARCHOS home screen”



- allows you to go back to the Home screen, and browse your hard drive or view your photos while listening to music.

“Set bookmark”



- sets a bookmark at the current spot in the song. Only one bookmark per file is allowed. You can bookmark up to 32 files.

- to resume playing a song from a bookmark, go to the Music Library or the Music Browser, highlight the bookmarked music file. Select the **“Bookmark”** menu item, then choose **“Resume”** (**“Clear”** will remove the bookmark from the song).

“Set rating”



- allows you to give a rating to the current song (1-5) or to remove the rating (none).

“Settings”



- you can choose to display the Music Player settings screen (see next section) or the **“Sound”** settings screen (see: *“Sound” Settings*).

2.3 MUSIC PLAYER SETTINGS

- In the Music mode, you can access the Music Player settings screen by using the **“Settings”** menu item .
- Use the left/right arrows to select a different setting for a parameter.

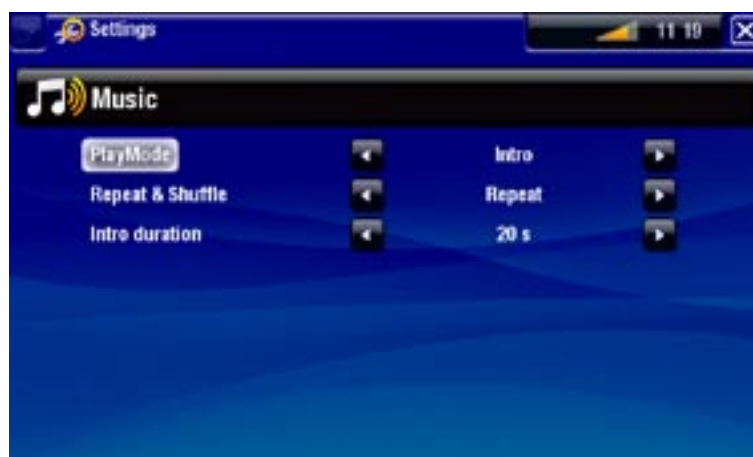

“PlayMode”, “Repeat & Shuffle”

- the following table explains how the audio player will work according to the settings you chose in “**PlayMode**” AND “**Repeat & Shuffle**”.
- An icon shows the current modes in the Music playback screen.

“PlayMode”	“Repeat & Shuffle”	What the music player does...
“Single”	“Normal”	- plays the current song and stops.
	“Repeat”	- plays the current song repeatedly.
“Folder”	“Normal”	- plays all the songs of the current folder one after the other, and then stops.
	“Repeat”	- plays all the songs of the current folder one after the other. This will be repeated indefinitely.
	“Shuffle”	- plays the songs of the current folder randomly.
“All”	“Normal”	- plays all the songs of your ARCHOS one after the other, and then stops.
	“Repeat”	- plays all the songs of your ARCHOS one after the other. This will be repeated indefinitely.
	“Shuffle”	- plays all the songs of your ARCHOS randomly.
“Queue”		<ul style="list-style-type: none"> - allows you to select a track to be played after the current one is finished. - while a track is playing, switch to the browser window, select a track to highlight it, then press OK. This is your queued track, which will be played after the current track. - you can only queue one track at a time, and you need to select the song to queue before the end of the current track.
“Intro”		- plays the first few seconds of each track. You can define the length to play in “ Intro duration ”. Press OK during the intro period to let the whole song play.

“Intro duration”

- defines for how long each track will be played when “**PlayMode**” is set to “**Intro**”.

2.4 PLAYLISTS



- A playlist is a list of audio tracks that the music player will automatically play one after the other.
- On your ARCHOS, you can play, create and edit as many playlists as you want.
- In the ARCHOS Browser, playlists are the files with the  icon.

Note: when you delete a playlist, you are only deleting the list and not the music itself.

PLAYING A PLAYLIST

- In the Music Library, highlight the “**Playlist**” line and press **OK** to display the available playlists.
- Highlight a playlist and press **OK**. A panel showing the contents of the playlist will open on the right.
- Open the first item in the playlist to start playing from the first track.



PLAYLIST MENU ITEMS

These menu items appear when a music file is highlighted on the left panel:

“Add to playlist”



-  - “**Selected file**”: will add the highlighted track at the end of the current playlist.
- “**All files**”: will add all the tracks (from the left panel) at the end of the current playlist.

“Insert in playlist”



-  - “**Selected file**”: will insert the highlighted track before the selected item in the current playlist.
- “**All files**”: will add all the tracks (from the left panel) before the selected item in the current playlist.

These menu items appear when the focus is on the right panel (playlist editor):



“Track”

-  - **“Remove track”**: deletes the highlighted track from the playlist.
-  - **“Move”**: allows you to change the position of the highlighted track within the playlist. Highlight the track you want to move, select the **“Track”** menu item, then choose **“Move”**. Use the up/down buttons to move the track and press **OK**.

“Playlist”

-  - **“Clear”**: clears the current playlist.
-  - **“Shuffle”**: randomly shuffles the order of the songs in the current playlist.

“Save playlist”

-  - **“Save”**: saves the current playlist to the **Playlists** folder.
-  - **“Save As”**: same as **“Save”**, but it also allows you to give a personalized name to the playlist using the remote control’s keyboard.

“Hide playlist”

-  - closes the playlist editor.

“Settings”

-  - you can choose to display the Music Player settings screen (see *Music Player Settings*) or the **“Sound”** settings screen (see: *“Sound” Settings*).

CREATING A NEW PLAYLIST

1. While you are in the Music browser, select the **“Show playlist”** menu item. A playlist panel will open on the right. By default, the new playlist contains the same songs as the last opened playlist. You can now start modifying the playlist.
2. In the left panel, locate the songs you would like to add to your playlist. Highlight a song and press **OK** to add it to the playlist. Repeat this operation with all the tracks you want.

To add all the songs of a folder to a playlist: open the folder in the left panel and highlight the first song. Then use the “Add to playlist” or “Insert in playlist” menu item and choose “All files”.

3. When you are satisfied with your new playlist, tab to the playlist pane, select the **“Save playlist”** menu item, and then choose **“Save as”**.
4. Enter the name of your new playlist using the remote control’s keyboard and press **“OK”**.

Use the tabs to jump back and forth between the left and right panels.

EDITING A PLAYLIST

To edit an existing playlist:

1. In the Music Library, highlight the “**Playlist**” line and press **OK** to display the available playlists.
2. Highlight the playlist you want to modify and press **OK**. A panel showing the contents of the playlist will open on the right.
3. You can now add, shuffle, move or remove tracks within the playlist, using the appropriate menu items. The available menu items will vary according to which panel you selected (see: *Playlist Menu Items*).
4. After you have made the changes you want, select the “**Save playlist**” menu item and choose “**Save**” to save the playlist. If you wish to give it a different name, choose “**Save As**”.

ADDING SONGS TO A PLAYLIST WHILE LISTENING TO MUSIC

1. While playing a song, use the tab button to go back to the Music Library or Music Browser, and select the “**Show playlist**” menu item.
2. The screen will then have two panels: the music files on the left and the last-opened playlist on the right.
3. While listening to your song, you can edit the last-opened playlist.
4. Close the playlist editor (Exit button **X**) to return to the playback screen.

Please note: this can only be done if you have entered the “Music” folder via the “Music” icon in the Home screen and not via the “Files” icon.

2.5 RECORDING ANALOGUE AUDIO



- Your ARCHOS Gives you the possibility to record audio from most any standard line level analogue audio source.
- See: *Recording Audio Manually*.

2.6 PLAYING YOUR PC'S SHARED MUSIC



- Using a WiFi or Ethernet connection, your ARCHOS gives you the possibility to play, directly on your TV, shared music stored in your PC's Windows Media® Library.
- For this to work, you will need a WiFi or Ethernet connection and Windows Media® Player 11 or higher* installed on your PC.

- The ARCHOS uses the UPnP (Universal Plug-and-play) standard to play streamed music from your PC's Windows Media® Library.
- See: *Playing your PC's Shared Media Files*.

** There are other products on the market that also can share media files using the UPnP standard.*

3. VIEWING PHOTOS



In the Home screen, select the “**Photo**” icon to enter the Photo viewer.

3.1 BROWSING THROUGH YOUR PHOTOS

- The “**Photo**” browser allows you to navigate through the **Pictures** folder of the ARCHOS’ hard drive.
- You can go back one level in the hierarchy by closing the current screen (Exit button **X**). Wherever you are in the hierarchy, you can go back directly to the Home screen by pressing and holding down on the Exit button.

THE PHOTO BROWSER

- The first screen of the Photo mode shows all the photos and subfolders located in the **Pictures** folder.
- To view a photo, highlight its thumbnail, then press **OK**. If a photo is in a subfolder of the **Pictures** folder, open the subfolder, and you will see your photo.
- The Photo Browser also allows you to view your pictures, sorted by date.



In the “Photo” browser each photo is displayed with a thumbnail.

PHOTO BROWSER MENU ITEMS*

“Info”



- displays a message box with information about the highlighted picture.

“Delete”



- allows you to delete the highlighted picture. A confirmation screen will pop up.

“Start slideshow”

-  - starts a slideshow from the highlighted image.
- the **“Pause slideshow”** menu item will appear, allowing you to pause the slideshow.

“Settings”

-  - will display the Photo viewer settings screen (see *Photo Viewer Settings*).

** The available menu items will vary depending on where you are in the “Photo” Browser.*





3.2 PHOTO VIEWER

To view a picture, highlight the corresponding thumbnail and press **OK**. The menu overlay will disappear automatically after a few seconds.

PHOTO VIEWER SCREEN



PHOTO VIEWER BUTTON CONTROLS

	- press once: close the photo viewer and go back to the “Photo” browser - hold: exit the Photo mode and go back directly to the Home screen.
	start/pause a slideshow
	zoom in
	left/right: previous/next picture down/up: rotate 90° clockwise/counterclockwise



	zoom out
	display/hide the menu overlay
M	display available menu items
+ -	increase/decrease volume
	Mute sound

PHOTO VIEWER MENU ITEMS

“Info”



- displays a message box with information about the current picture.

“Rotate”



- choose “**Left**” to rotate the picture 90° counterclockwise.

- choose “**Right**” to rotate the picture 90° clockwise.

“Start slideshow”



- starts a slideshow from the current image.

- the “**Pause slideshow**” menu item will appear, allowing you to pause the slideshow.

“Set as wallpaper”



- defines the current picture as your ARCHOS’ background image.

“Settings”



- will display the Photo viewer settings screen (see next section).

“Zoom”



- use the slider to magnify/demagnify the current picture.

3.3 PHOTO VIEWER SETTINGS

- In the Photo mode, you can access the Photo viewer settings screen via the “**Settings**” menu item.
- Use the left/right arrows to select a different setting for a parameter.



“Picture Pause”

- defines the time that each picture will be displayed during a slideshow.

“Transition”

- defines the transition effect to be used between two pictures. There are several cool effects that you can choose from.

“Sequence”

- allows you to enable/disable the shuffle mode. If this parameter is set to “**Shuffle**”, your pictures will be displayed randomly. To disable the shuffle mode, select “**Normal**”.

“Format”

- allows you to change the way the picture is displayed.
- “**Original**”: displays the entire picture in its original format.
- “**Full Screen**”: enlarges the picture to fill the screen. In order to fit the screen of your TV, your device might need to cut small parts of the image, most likely at the top and bottom.

“Anti-flicker”

- if you have a regular tube type television (CRT), you can set this to “**On**” if you find that some photos flicker.

3.4 PLAYING A SLIDESHOW

- To view a slideshow, highlight a picture file in the “**Photo**” browser or while viewing a photo, and choose the “**Start slideshow**” menu item.

- While a slideshow is playing, you can pause it at any time by selecting the “**Pause slideshow**” menu item.
- You can define the time that each picture is displayed and the transition effects in the “**Photo**” settings (see: *Photo Viewer Settings*).

3.5 VIEWING PHOTOS WHILE LISTENING TO MUSIC

You can view photos and play slideshows while listening to music:

- Choose the “**ARCHOS home screen**” menu item while playing a song.
- In the Home screen, select the “**Photo**” icon to enter the Photo mode.
- Browse through your photos (see: *Browsing Through your Photos*) or start a slideshow as normal (see: *Playing a Slideshow*).
- To go back to the Music playback screen, go to the Home screen and select the “**Music**” icon.

3.6 PLAYING YOUR PC'S SHARED PHOTOS



- Using a WiFi or Ethernet connection, your ARCHOS gives you the possibility to view, directly on your TV, shared photos stored in your PC's Windows Media® Library.
- For this to work, you will need a WiFi or Ethernet connection and Windows Media® Player 11 or higher* installed on your PC.
- The ARCHOS uses the UPnP (Universal Plug-and-play) standard to view streamed photos from your PC's Windows Media® Library.
- See: *Playing your PC's Shared Media Files*.

* There are other products on the market that also can share media files using the UPnP standard.

4. USING THE FILE BROWSER



The ARCHOS File Browser gives you the possibility to navigate the file system of your ARCHOS' hard drive. In the Home screen, select the **"Files"** icon to enter the File Browser.

You will see two panels:

- The one on the left is the panel that you usually use to navigate through your device's hard drive.
- The panel on the right is the one you will use to copy or move files and folders (see: *Copying and Moving Files and Folders*).



About your ARCHOS' hard drive:

DO NOT delete or rename the original folders: "Music", "Pictures", "Video", "Playlists", etc. The icons on the Home screen ("Video", "Music", "Photo"...) lead directly to these folders and they may no longer work correctly if the folders are deleted or renamed.

4.1 NAVIGATION

BUTTON CONTROLS

✕	- press once: go back one level in the hierarchy - hold: exit the File Browser and go back directly to the Home screen.
OK	open a file or folder
↶	scroll up the file list faster
⬆	left: go back up one level in the folder hierarchy up/down: scroll the file list up and down
↷	scroll down the file list faster
📄	jump between the left and right panels.

M	display available menu items
+ -	increase/decrease volume
⊗	Mute sound

BROWSER MENU ITEMS

Note that some of the above menu items may not appear if they are not available for the highlighted file or folder.

“Info”



- displays a message box with information about the highlighted file.

“Create folder”



- creates a folder at the current location.

- you will have to enter the folder's name using the remote control's keyboard.

“File Management”



- **“Rename”**: allows you to change the name of the highlighted file or folder using the remote control's keyboard.

- **“Delete”**: allows you to delete the highlighted file or folder (and all its contents). A confirmation screen will pop up.

“Copy”



- **“Copy”**: allows you to copy the highlighted file or folder to the location defined in the other browser panel.

- **“Copy all files”**: allows you to copy all the files of the current folder to the location defined in the other browser panel.

- **“Move”**: allows you to move the highlighted file or folder to the location defined in the other browser panel.

COPYING AND MOVING FILES AND FOLDERS

- In the left panel, highlight the file/folder that you want to copy or move.
- In the right panel, navigate to the location where you wish to copy the file/folder to.
- Go back to the left panel, select the **“Copy”** menu item and then choose **“Copy”**, **“Copy all files”** or **“Move”**, depending on the action that you want to carry out.

4.2 USING THE FILE BROWSER WHILE LISTENING TO MUSIC

You can browse your files while listening to music:







- Choose the “**ARCHOS home screen**” menu item while playing a song.
- In the Home screen, select the “**Files**” icon to enter the File Browser and start browsing through your files.
- To go back to the Music playback screen, go to the Home screen and select the “**Music**” icon.

4.3 USING THE PDF READER

- Your ARCHOS features a PDF reader with hyperlink support.
- In the Browser, PDF files are displayed with the  icon.
- To view a PDF document, highlight the PDF document in the File Browser and press **OK**.

ATTENTION: The ARCHOS PDF reader may not implement all PDF features. For example, you will not be able to open password protected PDF files.

PDF BUTTON CONTROLS

	- 1 st press: fit to width (if zoomed) - 2 nd press: exit PDF reader
	follow a highlighted link (surrounded by a red outline)
	previous page
	navigate within the current page
	next page
	-
M	display available menu items
+	-
-	-
	-

FOLLOWING HYPERLINKS

- Some PDF documents have hyperlinks (for instance, a table of contents, links to an external website, etc.).
- Links are surrounded by a blue outline. A highlighted link (active link) is surrounded by a red outline.
- If you want to go back to the previous page (where you 'clicked' the link), select the "**Link back**" menu item.

Note that hyperlinks referring to an external document or to a URL may not work.

PDF READER MENU ITEMS

"Hide text overlay"

- will hide all overlaid graphics (status bar, menu items, etc.) to only show the PDF document.

"Zoom"

- allows you to adjust the zoom level.

"Previous page"

- goes to the previous page in the document.

"Next Page"

- goes to the next page in the document.

"Link back"

- will take you back to the page that you came from.
- only appears when you have previously followed a link.

"Go to page..."

- allows you to select a specific page.
- use the left/right buttons to select a page number.
- press "**Ok**" to go to this page.

5. USING THE WIFI FEATURES



When connected to a WiFi or Ethernet network, your ARCHOS gives you the possibility to:

- rent or purchase online videos/music via the ARCHOS Content Portal. See: *The ARCHOS Content Portal*.
- browse the web with the optional Web Browser plug-in, available at www.archos.com. See next section.
- play shared media files stored on other computers in your network. See: *Playing your PC's Shared Media Files*.

- *The first time you turned on your ARCHOS, the installation wizard helped you configure the WiFi and Ethernet connection.*
- *Every time you restart your ARCHOS, your device will automatically connect to the last configured network.*
- *If you want to change your Network configuration, select the "Settings" menu item from the Home screen, and choose "Network". See "Network Settings".*

5.1 BROWSING THE WEB



In order to browse the web, you will need the Web Browser plug-in, available at www.archos.com. With this Internet browser, specially designed for your ARCHOS, you will have the possibility to browse websites*, use web-based e-mailing, download content, etc.

**supports Flash® content and Javascript. Java virtual machine not supported.*

LAUNCHING THE WEB BROWSER

From the Home screen, select the "**Web**" icon.

- If you are already connected to a network, the Web browser will simply open and you can start browsing the Web.
- If WiFi / Ethernet is not enabled or if you are not connected to a network, the device will scan for available networks and connect to a known network or display the list of available networks so that you can connect to one of them.
- Please note: not all wireless / Ethernet networks offer access to the Internet. Some WiFi or Ethernet networks only link several computers together, without any Internet connection.

If the time and date are not correctly set, you might not be able to access certain web pages (See: “Clock” settings). If you choose to set the clock automatically when the ARCHOS connects to a WiFi / Ethernet network, you will need to select your Country and City/Zone (see: “Language and Region” Settings).

USING THE WEB BROWSER

- You can use the Web browser to read your Web-based e-mail, view Web sites, and download documents from the Internet.
- The menu overlay will disappear after a few seconds.
- The Web browser features ‘tabbed browsing’. You can have several pages opened at the same time. They will appear in the tabs area, in the upper left corner of the screen. When several pages are open, simply select a tab (using the Tab button) to access the page that you want. See next section.



WEB BROWSER BUTTON CONTROLS

See: *The Remote Control*.

BROWSER MENU ITEMS

“Reload” / “Stop”

- will stop loading the web page, if it is currently loading.
- will refresh the current web page, if it has stopped loading.

“Navigation”

- **“Forward”**: will go to the next page that you browsed.
- **“Back”**: will go back to the previous page that you browsed.

“Zoom”

- changes the way the web page is displayed. Select a zoom mode.

“Go to”

- **“Enter URL...”**: allows you to enter the address of a Web site you’d like to visit. Enter the address using the remote control’s keyboard. Press **“OK”** to open the website in the current window, or select the menu item **“Open in new tab”** to open it in a new window.
- **“Search...”**: allows you to search an address in one of the configured search engines. Enter the key words using the remote control’s keyboard. Press **“OK”** to open the results in the current window, or select the menu item **“Open in new tab”** to open them in a new window.

“Favorites”

- will open the **“Favorites”** manager. Here you can add favorites, rename or delete them. Select a favorite and use the **“Open in new tab”** menu item to open the corresponding web page in a new window.

“Settings”

- will open the **“Web Browser”** settings screen. Here you can decide whether to accept/ignore popup windows, enable/disable flash content, delete your Internet history and cookies, etc.

Please note that some Web features requiring special plug-in software or Active X controls may not work in this special version of the Web Browser.

5.2 PLAYING YOUR PC’S SHARED MEDIA FILES



Streaming one of your PC’s shared videos and displaying it on your TV

- When connected to your home WiFi / Ethernet network, your ARCHOS gives you the possibility to watch, directly on your TV, shared media files (videos, music or photos) stored in your PC’s Windows Media® Library.

- For this to work, you will need a WiFi /Ethernet connection and Windows Media® Player 11 or higher installed on your PC*.
- This is especially useful when you have a large library of music and video and you cannot fit it all onto the internal hard drive of the ARCHOS.
- The ARCHOS uses the UPnP (Universal Plug-and-play) standard to play streamed media files from your PC's Windows Media® Library.

** If you cannot install Windows Media® Player 11 or higher, it is possible to access and stream your PC's files from the ARCHOS File Browser. See Browsing Other Computers on the Network.*

SETTING WINDOWS MEDIA® PLAYER'S SHARING OPTIONS

1. Connect the ARCHOS to your WiFi / Ethernet network. See "Network" Settings.
2. Connect your PC to the same WiFi / Ethernet network and start Windows Media® Player, version 11 or higher.
3. Click on the **Library** tab, and select **Media sharing...**
4. Check the box **Share my media to**, and click on **OK**. The ARCHOS' icon should appear in the window, with a warning symbol next to it*.



** ATTENTION: the first time you set your sharing options, it might take a couple of minutes for your PC to display the ARCHOS' icon.*



5. Select the ARCHOS' icon and click on the **Allow** button.
6. To modify your sharing settings, click on **Settings**. You can, for example, enter a name for your shared media files. You will then see this name on your ARCHOS. Click on **OK** to save the modifications.
7. Click on **OK** to close the **Media Sharing** window.
8. You can now close Windows Media® Player, and start viewing your PC's shared media files directly on your ARCHOS (see next section).

PLAYING YOUR SHARED MEDIA FILES ON THE ARCHOS

Your PC needs to be connected to the same WiFi / Ethernet network as the one the ARCHOS will connect to. You also need to have configured Windows Media® Player's sharing options (see the previous section).

1. On your ARCHOS, enter the Video, Music or Photo mode.
 2. You will notice that the first item in the list is the shared media files: "**Network 'UPnP'**". Open this item to start scanning for devices and computers sharing their media files on the WiFi / Ethernet network.
 3. If you entered a name for your shared media files in Windows Media® Player, it should appear. Open it, and you will see all your shared videos, songs or photos.
- If you are in the Video mode, you will then have access to all the videos stored in your PC's Windows Media® Library.
 - In the same way, the Music and Photo modes will allow you to access all the music/photos stored in your PC's Windows Media® Library.

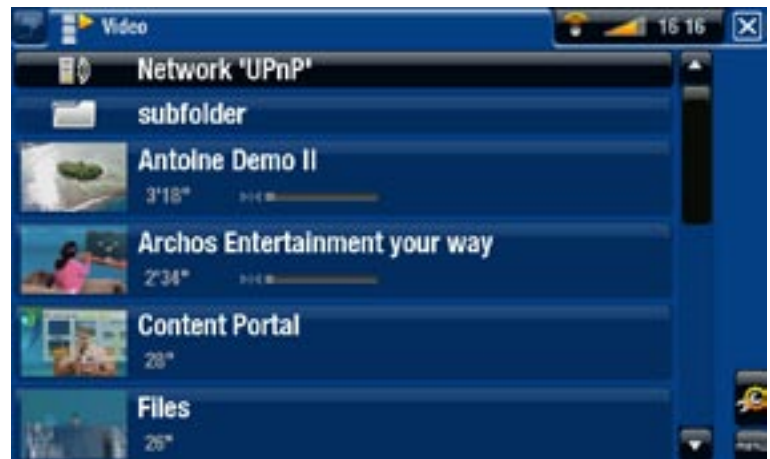

Note: You may have some video files of very high quality and these require that the WiFi connection transfers data at a high speed. If your ARCHOS is far away from your WiFi box, it may happen that the connection speed is reduced thus not allowing some video files to stream from your PC to the ARCHOS and the television.

5.3 THE ARCHOS CONTENT PORTAL



- The ARCHOS Content Portal is an online store that offers several video and music partners.
 - This portal gives you access to video and music content that is either free, for rent, or for purchase.
1. In order to activate the ARCHOS Content portal, you will need to register your ARCHOS product online on the ARCHOS web site (www.archos.com/register).
 2. Make sure you have configured your ARCHOS on a WiFi / Ethernet network (see: "*Network*" Settings).



3. Select the ARCHOS "**Content Portal**" icon to view available online media stores and purchase videos or songs.

Depending on your connection speed, you will have the possibility to start playing the video/song you purchased or rented while it's being downloaded (streaming content websites start to play instantly). The videos/songs you get from the ARCHOS Content Portal are saved in the "Video"/"Music" folders.

6. TRANSFERRING FILES

6.1 USB HOST CONNECTION

- *The ARCHOS allows you to connect a USB external device, so that you can transfer files or play content directly on the ARCHOS.*
- *These devices can be Mass Storage Class (MSC) devices, such as digital cameras, card readers, or external hard drives, or digital cameras using the Picture Transfer Protocol (PTP).*
- *Check your manufacturer's information to find out whether your device is an MSC or PTP device. Non Mass Storage Class devices such as printers, Ethernet adapters, mice, keyboards, etc. are not supported.*

1. Once the ARCHOS is on, connect the external USB device (with a standard USB cable if needed) into the **USB A** port.
2. Turn on the external USB device if needed (check the documentation of your external USB device).
3. A double browser window will appear on the TV screen: the external USB device will appear in the left panel, and your ARCHOS device's hard drive in the right panel.*

* *You can also access the contents of your USB device from the "Video", "Music" and "Photo" browsers.*

4. You can then play files directly from the USB device. To transfer files to/from your USB device using the double browser, see *Copying and Moving Files and Folders*.

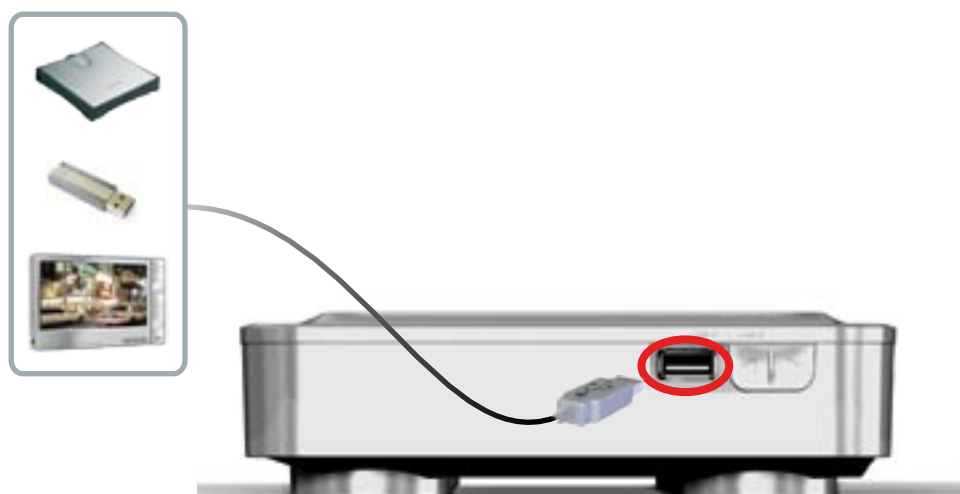

TO DISCONNECT

1. Make sure that no transfer is being made.
2. From the Home screen, select the “**Remove safely**” menu item.
3. You can now pull out the USB cable on either end.

Note: you may not always be able to copy files to your external USB device from your ARCHOS.

6.2 BROWSING OTHER COMPUTERS ON THE NETWORK

- When you are connected to a Windows® network, you can browse* the shared folders of other computers in the network, using the ARCHOS File Browser.
- From the Home screen, select the “**Files**” icon. In the left panel of the browser, select the first line in the list (“**Network**”). Your device will connect to your WiFi / Ethernet access point and then search for other computers in the Windows® network. You can then choose a computer and start browsing its shared folders.

** If the computer with the shared folders normally has a Windows® username and password, you will be asked to enter these before you can access the folder contents.*

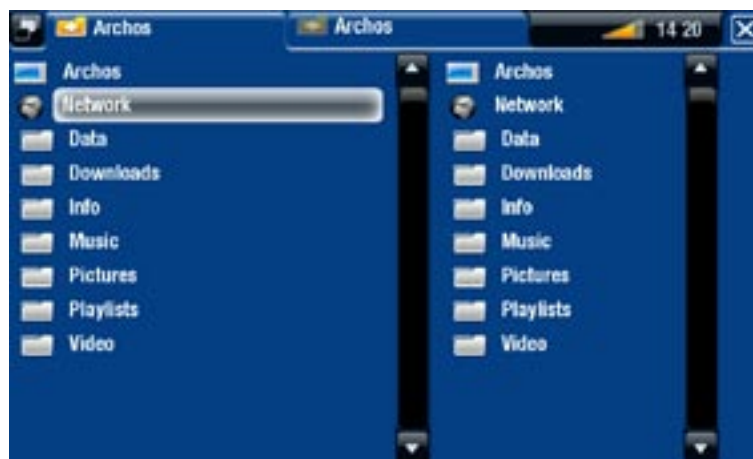

Using the ARCHOS double browser, you will be able to play media files or transfer any file from a networked computer onto your device. You can also transfer files from your device onto a computer’s write-enabled shared folder (see *Copying and Moving Files and Folders*).

If the WiFi is not enabled or if you are not connected to a network, the device will scan for available networks and connect to a known network or display the list of available networks so that you can connect to one of them.

6.3 CONNECTING THE ARCHOS TO A COMPUTER

CONNECTION STEPS

1. Plug a USB cable (not supplied) into the ARCHOS (**USB B** port).
2. Plug the other end of the USB cable into your running computer.

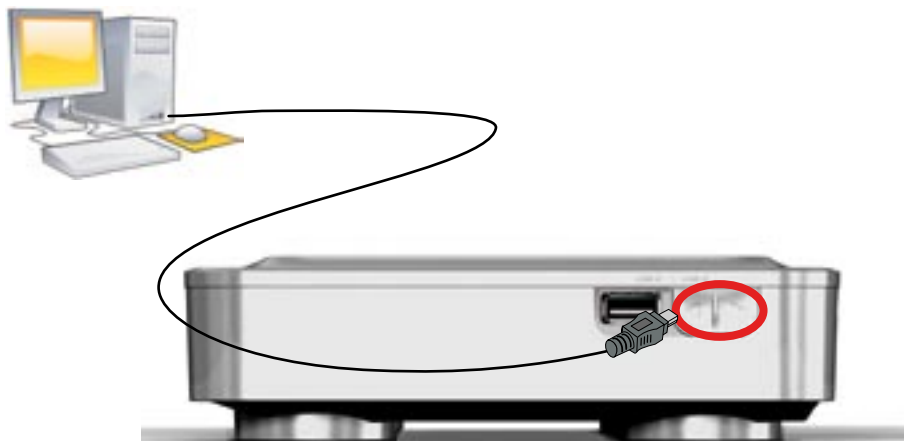

3. The ARCHOS' icon will appear on your computer. You can now start transferring files to it.

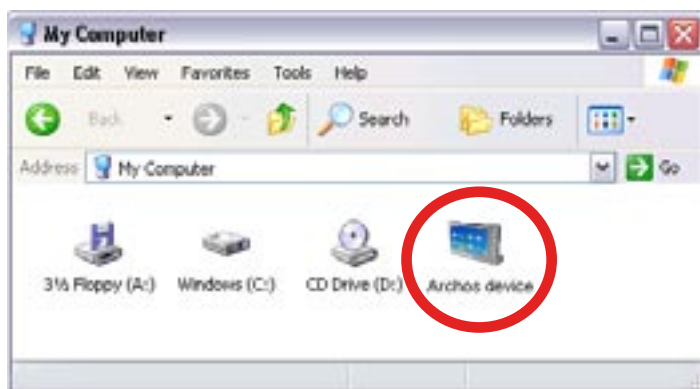

You cannot copy files larger than 2 GB to the ARCHOS due to the FAT32 file system constraints. For advanced users: in "PC Hard Drive" connection modes (mode 2 and 3), the maximum size is 2 GB for .AVI files and 4 GB for any other type of file. See: "System" Settings.

DISCONNECTING

When you disconnect the ARCHOS from a computer, your device automatically updates the ARCLibrary, so that the media files you just copied appear in the Music and Photo Libraries.

Windows® XP or higher & WMP10 or higher

- Verify that no data are being transferred between your ARCHOS and your computer.
- Now unplug the USB cable from your ARCHOS and/or computer.

Windows® 2000 or Me

DO NOT SIMPLY PULL OUT THE CABLE AT ANY TIME! You must remove/unmount the ARCHOS from the computer before disconnecting the USB cable to avoid loss of data or freezing.

- Once all your transfers are finished, click on the 'safely remove' icon in the system tray, next to the clock.
- Click on the 'safely remove' message.
- A message will pop up, telling you that it is now safe to disconnect the device*. You can now safely unplug the USB cable from your ARCHOS and/or computer.



** If you get a message saying that the device cannot be removed, close any computer program that may still be using data on your device, such as media players or Windows® Explorer.*

Mac® OS X

DO NOT SIMPLY PULL OUT THE CABLE AT ANY TIME!

You must remove/unmount the ARCHOS from the computer before disconnecting the USB cable to avoid loss of data or freezing.

- On your desktop, drag the ARCHOS' icon towards the trashcan, which will turn into a big eject symbol.
- Drop the icon onto this eject symbol: the ARCHOS' hard drive will disappear from the desktop.
- You can now safely unplug the USB cable from your ARCHOS and/or computer.

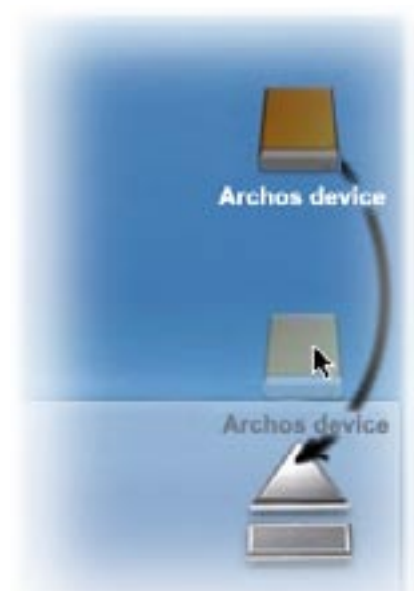

Linux

DO NOT SIMPLY PULL OUT THE CABLE AT ANY TIME!

You must remove/unmount the ARCHOS from the computer before disconnecting the USB cable to avoid loss of data or freezing.

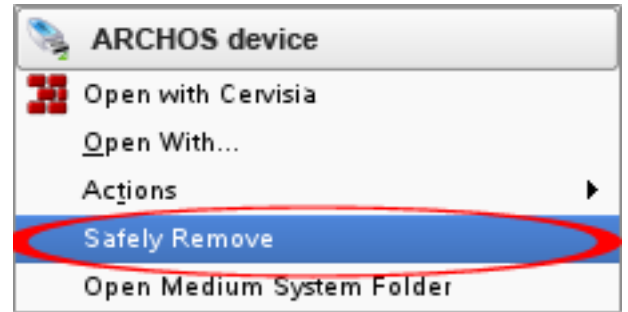

- On your computer, right-click on the ARCHOS icon and select Safely Remove.
- Wait until the ARCHOS icon disappears, and safely unplug the USB cable from your ARCHOS and/or computer.

7. MAIN SETTINGS

In the Home screen, select the “**Settings**”  menu item and choose a setting.

USING THE BUTTONS

- To open a settings screen, press the Menu button **M** and use the navigation buttons to highlight the “**Settings**”  menu item. Then, select the setting you want to modify (“**Sound**”, “**TV Settings**”, “**Appearance**”, etc.) and press **OK**.
- Once you are in a settings screen:
 - use the up/down navigation buttons to highlight a parameter.
 - use the left/right navigation buttons to select a different setting.
 - when you have finished adjusting your settings, press the Exit button **X** to save them and go back to the Home screen.
 - When it is possible, use the up/down navigation buttons to scroll the screen up and down.

7.1 “SOUND” SETTINGS

This screen allows you to adjust the sound settings of your ARCHOS to your personal taste.



“Audio Output”

- defines whether the audio signal is sent out via the “**Analog Line-Out**”, “**HDMI**” or “**SPDIF**” interface depending on how you have connected the ARCHOS to your TV.

“Bass Boost Level”

- adjusts the bass boosting level.

“Preset”

- allows you to quickly select a sound profile.

“Set Equalizer”

- allows you to use a custom sound profile. Select this option to enter the equalizer screen (see next section).

“Balance” (not available in HDMI output mode)

- allows you to balance the sound between the left and right stereo channels.

“Reset”

- resets the sound parameters to the default values.

“EQUALIZER” SCREEN

- Your ARCHOS features a 5-band equalizer.
- Select a band (Bass, Mid. bass, Mid. range, Mid. treble or Treble), then use the up/down arrows to change the gain level for these frequency ranges.



It is advised that you change these settings while listening to music, in order to be able to appreciate the sound changes.

7.2 “TV SETTINGS”

These settings could potentially make your screen go blank. You will need to select the **“Apply change”** button before anything happens. Read the on-screen messages VERY CAREFULLY so that you do not get stuck with a blank screen.



“TV Connection”

- select the type of video output (**“Composite”**, **“S-Video”**, **“Component”**, **“RGB”** or **“HDMI”**), based on how you have connected the ARCHOS to your TV.

“Resolution” *

- select the resolution that best adapts to your TV: **“VGA 4/3 (640x480 60Hz)”**, **“480p 16/9 (720x480 60Hz)”** or **“576p 16/9 (720x576 50Hz)”**.

** This parameter only appears if you choose the “HDMI” TV connection mode.*

“TV Standard” **

- choose between the **“NTSC (USA)”** and **“PAL (Europe)”** systems (select the one that is compatible with your country’s television system).

“TV Format” **

- **“4:3”** or **“16:9”** - the format used by your television set to display images.
- the option **“Wide screen”** becomes available when you set the **“TV standard”** parameter to **“PAL (Europe)”**.

**** These parameters do not appear if you choose the “HDMI” TV connection mode.**

“Audio Output”

- defines whether the audio signal is sent out via the **“Analog Line-Out”**, **“HDMI”** or **“SPDIF”** interface depending on how you have connected the ARCHOS to your TV.

“Apply change”

- use this button to apply your changes.

7.3 “APPEARANCE” SETTINGS



“Picture name”

- allows you to select a picture to use as a wallpaper image. Select **“None”** if you do not want any background image.
- you can choose between all default backgrounds or the images that you have previously set as wallpapers.
- you can also set a picture as wallpaper from the Photo and Video modes.

“Theme color”

- defines the theme color for your icons (and for the background, if you have disabled the use of a wallpaper).

“Cancel”

- use this button to discard any changes you may have made since entering this screen.

7.4 “NETWORK” SETTINGS

- *The first time you turned on your ARCHOS, the installation wizard helped you configure the WiFi and Ethernet connections.*
- *Every time you restart your ARCHOS, it will automatically connect to the last configured network.*
- *This section explains how to change your Network configuration, for example if you want to connect to a different network.*

- This screen displays your connection status.
- Select the “**Network Details**” button to view the information concerning the network the ARCHOS is currently connected to: IP, security details, etc.
- You have the possibility to connect to the internet via the WiFi or via an Ethernet cable.

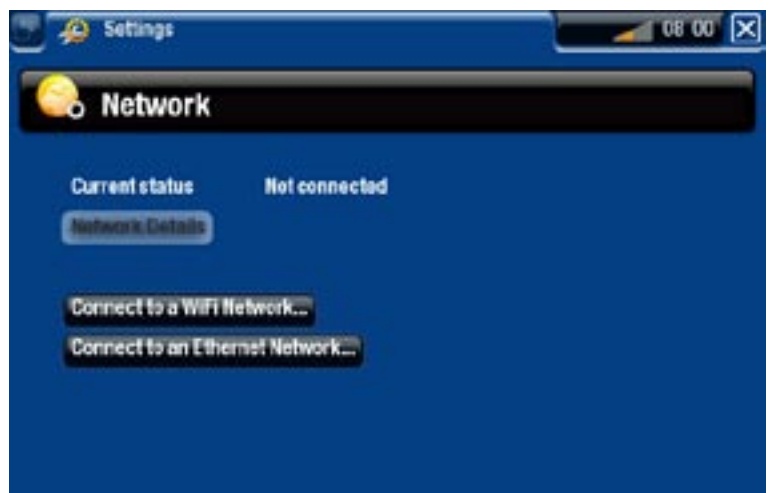

ETHERNET CABLE CONNECTION

- Select “**Connect to an Ethernet Network...**”
- Use the same procedure as for a WiFi open network when using an Ethernet cable.
- Jump ahead to the WiFi section *Open Networks*.

WIFI CONNECTION

When you select “**Connect to a WiFi Network...**”, The ARCHOS will scan for available networks. The list of available networks will be displayed.

The List of Available Networks

- The list of available networks shows all the wireless networks in range of your device.
- In the list of available networks, you will see the following information:





1.	Configuration status: configured network unconfigured network
2.	The name of the network (SSID), if it is broadcasted (<i>if the SSID is not broadcasted, you will be prompted to enter it in the next configuration screen if you configure this network</i>).
3.	The strength of the signal.
4.	The type of encryption key that is required: Open network (no key) WPA key WEP key WPA2 key
5.	The channel used by the network.
6.	The type of network (Infrastructure or Ad-Hoc). <i>Ad-Hoc networks are not supported at this time.</i>

- Use the navigation buttons to highlight a network and press **OK**.
- You will be taken to the configuration screen for this network, where you will have to enter some information to set up your access to this network.

WiFi Network Configuration

In order to connect to a wireless network, the ARCHOS will need some specific information about the network. Your device will automatically pick up certain pieces of information that it needs from the WiFi router. You can enter the rest of the information manually in the network's configuration screen, as shown in the following sections.

Open Networks (also valid for Ethernet cable connection)

- Open networks do not require an authentication key.
- If the network has automatic configuration turned on (DHCP)*, simply select the "**Connect**" button, and your ARCHOS will connect to this network, provided the signal is strong enough.

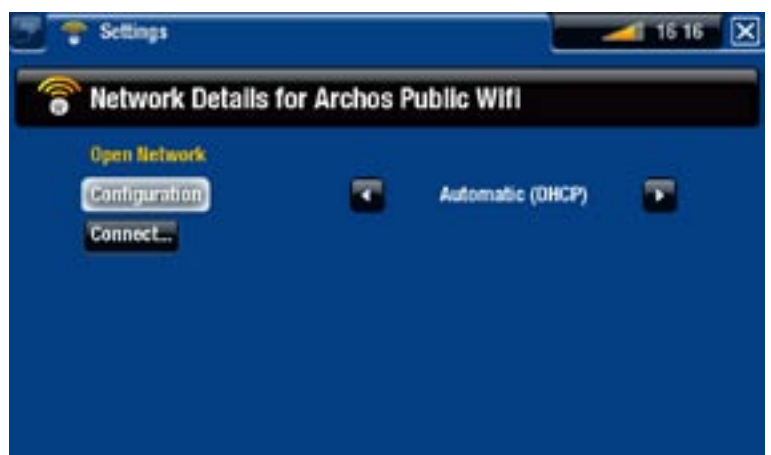

* *Most networks support DHCP.*

- If the network needs to be configured manually, use the left/right arrows to select the “**Manual**” setting on the “**Configuration**” parameter.
- Other parameters will appear: the required information can be obtained from the person who manages the network.

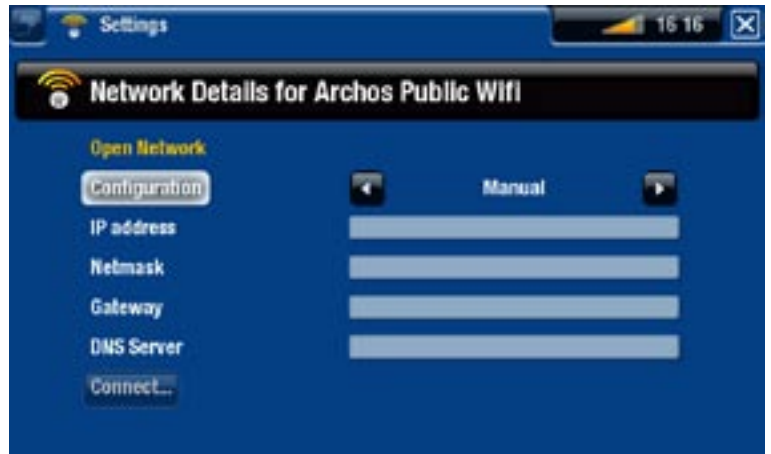

When you have finished entering all the information, select the “**Connect**” button, and your ARCHOS will connect to this network, provided the signal is strong enough.

Protected Networks (WEP, WPA or WPA2 KEY)

- Protected networks require an encryption key to connect.
- The type of key (WEP, WPA or WPA2) will be detected automatically by your device.
- The rest of the required information can be obtained from the person who manages the network.



You will have to specify the following settings:

“Key length” (for WEP networks only)

- the authentication key can be 10 characters long (64bit) or 26 characters long (128bit).

“Key format” (for WEP networks only)

- in some cases you may need to change the key format in order to enter a passphrase/password. *See the documentation that came with your WiFi router or modem.*

“Key” (WEP or WPA)

- press **OK**, enter the encryption key using the remote control’s keyboard and press **OK** again to validate.

“Authentication” (for WEP networks only)

- the network’s authentication method can be based on an “**Open System (default)**” or a “**Shared Key**”.

“Configuration”

- it can be **“Automatic (DHCP)”** or **“Manual”**.
- if it is **“Automatic (DHCP)”**, then you do not have to enter any more information. Simply use the **“Connect”** button, and your ARCHOS will connect to this network, provided the signal is strong enough.
- if you must configure the network manually, select the **“Manual”** setting. Other parameters will appear: the required information can be obtained from the person who manages the network.

When you have finished entering all the information, use the **“Connect”** button, and your ARCHOS will connect to this network, provided the signal is strong enough.

Filtered networks: If your network manager allows only specific devices to connect to the network (known as MAC address filtering), you can supply the network manager with the MAC address of your ARCHOS. To find out what your MAC address is, select the “Settings” menu item from the Home screen, then choose “System”. See: “System” Settings.

7.5 “LANGUAGE AND REGION” SETTINGS



“Language”

- choose a language.
- visit www.archos.com to check the availability of other languages. New languages are included in the firmware as they become available. See *Updating the Firmware*.

“Select location”

- if your clock is set to **“Automatic”** (see *“Clock” Settings*), select your **“Country”**, and **“City/Zone”**.

“WiFi Region”

- this is configured automatically according to how you set your location.

7.6 "TV CONTROL" SETTINGS

- This is where you can set the ARCHOS' infrared emitter to communicate with your tuner. This will allow the TV+ to turn on and change the channels of your tuner (satellite receiver, set top box, VCR, DSL box) in order to make the scheduled recordings one sets in the ARCHOS TV Program guide.
- See *The TV program Guide*.

7.7 "CLOCK" SETTINGS



If you use the ARCHOS to schedule video recordings on your TV system, make sure that the time and date are set correctly!

"Time Format"

- choose between 12h or 24h mode.

"Time setting"

- "**Automatic**": select this parameter if you want to set the clock automatically when your ARCHOS is connected to a WiFi / Ethernet network. You will need to select your location in the "**Language and Region**" settings screen (see: "*Language and Region*" Settings).
- "**Manual**": select this parameter to set the current date & time manually. The following parameters will appear: "**Hour**", "**Minute**", "**Year**", "**Month**" and "**Day**".

"Synchronize now"

- if the "**Time setting**" parameter is set to "**Automatic**", use this button to set the clock automatically via a WiFi / Ethernet network.
- for this to work, the ARCHOS needs to be connected to a WiFi / Ethernet network.

ATTENTION: If the time & date are not correctly set, you might not be able to access certain web pages.

“Hour”, “Minute”, “Year”, “Month”, “Day”

- these parameters allow you to set the current time and date manually.

7.8 “FIRMWARE AND PLUG-INS” SETTINGS



“Firmware Ver.”

- displays the current version of the firmware and Digital Rights Management (DRM) system.

“Plug-ins”

- displays the current plug-ins installed on your device.

“Product Key”

- each ARCHOS has a unique number.
- you will need this number to register your product online (www.archos.com/register).

“Firmware Update”

- use this button to update the firmware manually (see next section).

“Online Firmware Update”

- use this button to search for an online update via a WiFi / Ethernet network. If there is one available, it will be installed automatically. See next section to learn more.

7.9 UPDATING THE FIRMWARE

The firmware is the operating system (OS) of your ARCHOS. It is periodically updated to bring new features, improvements and bug fixes. There are two main ways to update your product’s firmware:

- Directly on the ARCHOS TV+ via a WiFi / Ethernet network.
- Using a computer connected to the internet and a USB key.

UPDATE DIRECTLY ON THE ARCHOS (WIFI / ETHERNET CONNECTION NEEDED)

This is the easiest way to update the firmware. For this to work, you only need an access to a WiFi / Ethernet network. See “*Network*” Settings.

1. From to the Home screen, select the “**Settings**”  menu item, and choose “**Firmware and Plug-ins**”.
2. Use the “**Online Firmware Update**” button.
3. The ARCHOS will search online for a new firmware. If there is one available, it will start downloading, and it will be installed automatically.

UPDATE USING A COMPUTER (INTERNET CONNECTION NEEDED)

If you cannot connect your ARCHOS to a WiFi / Ethernet network, you can also update the firmware using a computer connected to the internet. You will also need a USB key (64 MB minimum size).

1. Connect the USB key to your computer and go to www.archos.com/firmware on your web browser.
2. Search for the latest firmware available for your ARCHOS TV+.
3. Compare the latest online version with the one currently installed on your ARCHOS: your ARCHOS’ firmware version number appears in the “**Firmware and Plug-ins**” settings screen (see: “*Firmware and Plug-ins*” Settings).
4. If the online version is more recent than yours, save the file (file type .AOS) directly onto your USB key (place it at the root, that is to say not in any folder on the USB key).

Your Internet browser may warn you that the contents of the firmware file could harm your computer. ARCHOS has taken precautions to insure that this file will not harm your computer.

5. With your ARCHOS TV+ on and with the home screen displayed, plug the USB Key into the USB Port of the TV+. Wait for the TV+ to recognize the USB key and then follow the on-screen instructions.

7.10 “SYSTEM” SETTINGS



“Free Storage Space”

- displays the amount of free space on the hard drive.

Note: reported number of megabytes is binary-based counting (1Kb=1024 bytes). Thus each reported Mb represents approximately 1.05 megabytes (decimal), and each reported Gb represents approximately 1.07 gigabytes. Formatting also takes up space.

“USB preference” (for advanced users)

- Your preferred connection mode will be used every time you connect the ARCHOS to a computer with an optional USB cable. The connection mode determines how your device interacts with your computer:
- Mode 1: **“Windows Media Device”**: Recommended for users of Windows Media® Player (WMP) version 10 or higher. When set to this mode, the ARCHOS uses the Media Transfer Protocol (MTP). You will be able to synchronize your media library automatically if you connect your ARCHOS to your computer via an optional USB cable. When your file transfer is finished, simply unplug the cable from the ARCHOS, and your device will update the ARCLibrary (Music/Photo libraries).
- Mode 2: **“PC Hard Drive”**: Recommended for users of Windows® XP with Windows Media® Player 9, Windows® 2000, Me, Mac® OS X or Linux. Disconnection: when the file transfer is over, safely unmount the ARCHOS (See: *Disconnecting*) and your device will do a quick ARCLibrary update (Music/Photo libraries). May not index all files.
- Mode 3: **“PC Hard Drive (auto-ARCLib)”**: Same as mode 2, but with a full ARCLibrary update (Music/Photo libraries) at disconnection.

“Update ARCLibrary”

- Available only when **“USB Preference”** is set to **“PC Hard Drive”** (mode 2).
- This USB mode only does a quick ARCLibrary update (Music/Photo libraries). Use the **“Update ARCLibrary”** button if you want to do a full ARCLibrary update.

“Product Key”

- each ARCHOS has a unique number.
- you will need this number to register your product online (www.archos.com/register).

“MAC addresses”

- some WiFi / Ethernet networks filter MAC addresses. You might need to communicate these addresses to the person who manages the network.

“Repair and Formatting Tools”

- use this button to access the **“Repair and Formatting Tools”** settings screen. This screen allows you to do the following actions:
- **“Clear temporary system files and cache”** (does not erase any data)
- **“Reset Settings”** (resets all user settings)

- **“Format Hard Drive”** (erase all data, media files, and licenses)
- **“Full Reinitialization”** (erase all data, media files, licenses and settings)

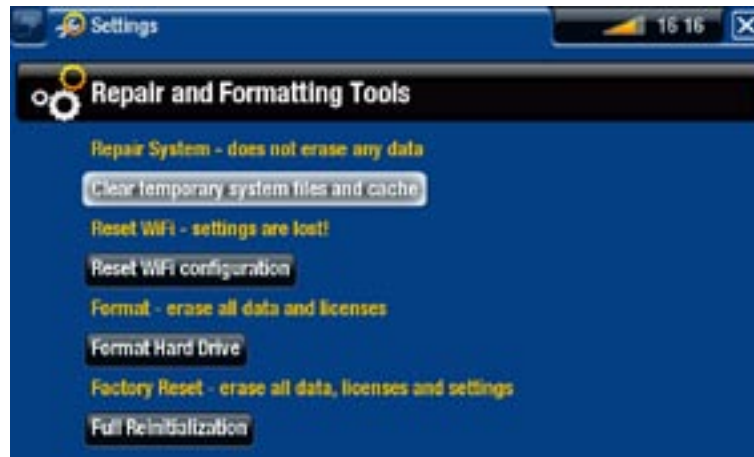

In the event that your ARCHOS freezes or does not respond anymore, try to restart it by disconnecting / reconnecting the power adapter (see: Troubleshooting).

If this does not work or if you cannot access the Repair and Formatting Tools, you can try a system recovery (see: Troubleshooting).

8. TV RECORDING: HARDWARE SETUP



When connected to your home tuner (cable box, satellite receiver, digital tuner, DSL box or VCR), you will be able to schedule recordings manually or via the ARCHOS TV Program Guide (EPG).

8.1 CONNECTION PRINCIPLES

- The ARCHOS is a '**pass-through**' device. This means that when it is off or when you press the **TV** button, it simply passes the audio and video signals (from cable box, satellite receiver, digital tuner, etc.) through the ARCHOS to your television (not in HDMI output mode).
- What this means is that you will place the ARCHOS 'between' your television reception device (Cable box, satellite receiver, Digital TV receiver, etc.) and your television. See diagrams on next page.
- When connecting cables between devices, always remember that the **OUT** connectors of one device must be connected by cables to the **IN** connectors of the next device. You can think of it as the signals traveling out of one device into the next device. Finally, make sure that you always **match the color** of the connector with the color of the jack it is being plugged into.

8.2 CONNECTING A TUNER TO YOUR ARCHOS

This shows the basic connection setup of a television source (tuner), the ARCHOS, and your TV.

1. Your tuner needs to be connected to your home antenna/satellite/cable.
 2. Connect your tuner's TV outputs to the ARCHOS' inputs (see diagrams on next page).
 3. The ARCHOS' outputs should already be connected to your TV. If not, see diagrams on next page.
- ✓ If you can still watch TV when the ARCHOS TV+ is off (but plugged in), it means that you have correctly connected the ARCHOS as a pass-through device.
 - ☒ If you cannot watch TV anymore, this means that there is an incorrect connection. Check the previous connections steps carefully.

Connection Diagram for Europe:

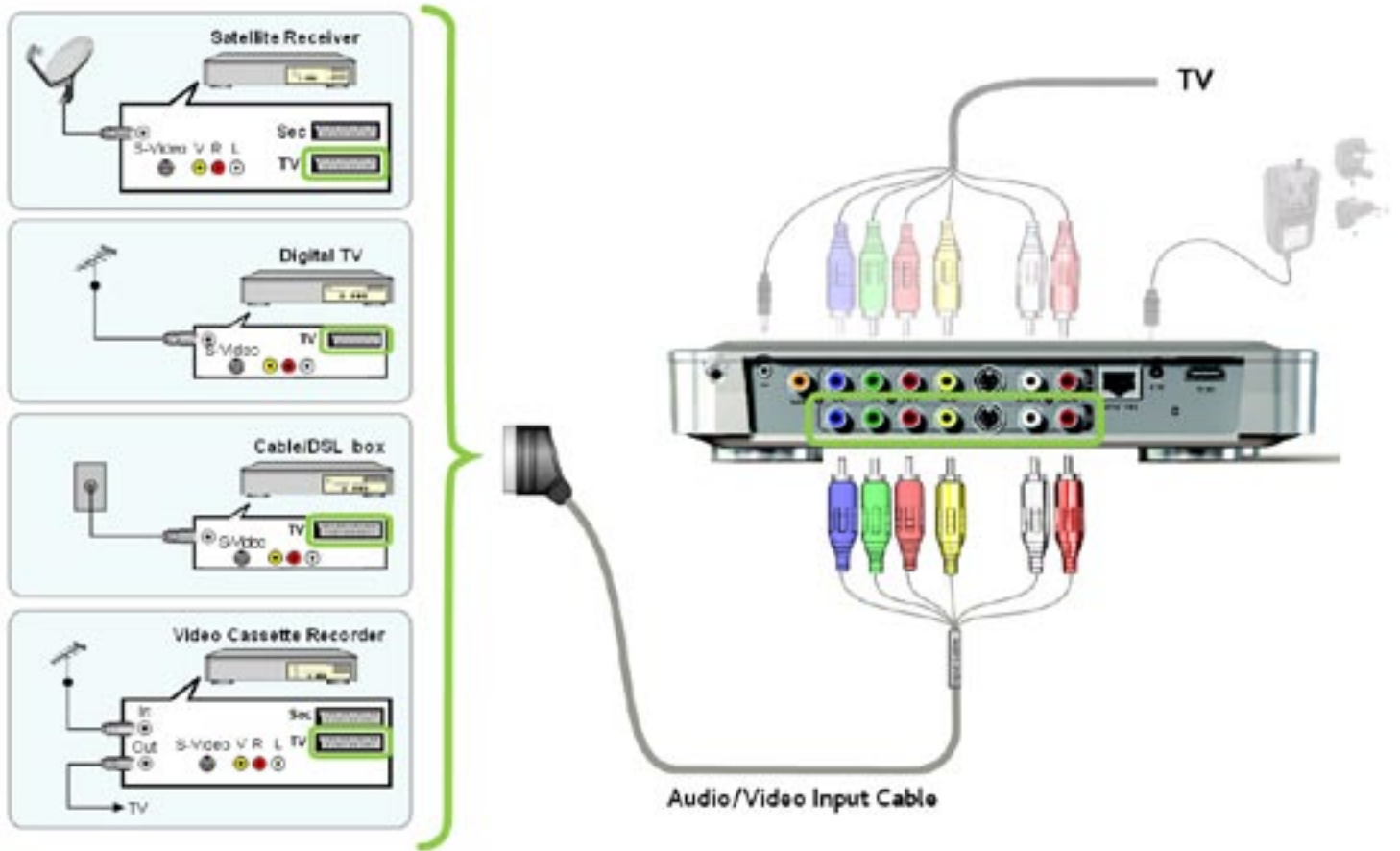

Connection Diagram for North America: *

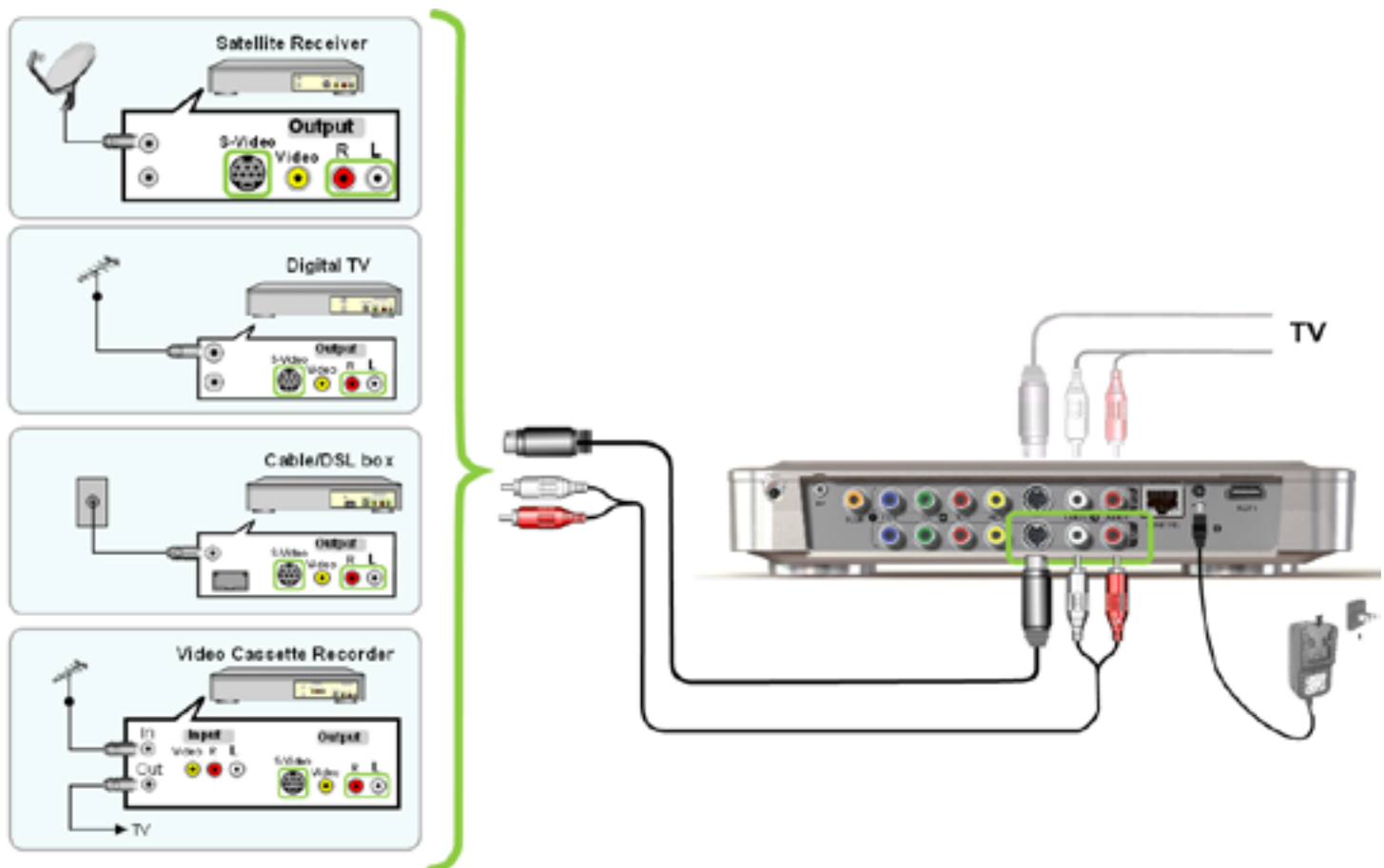

** North America: if either your tuner or TV does not have S-video connections, use standard male/male RCA cables instead of the supplied S-video cables.*

ARCHOS PASS-THROUGH TABLE

The ARCHOS will pass through the following video signals when it is off, or when you press the TV button on the remote control:

Video input	Video Output	Pass-through
Composite <i>yellow connector or supplied scart (Europe)</i>	Composite <i>yellow connector</i>	Yes
	S-Video	No <i>will only show black & white image</i>
	RGB <i>(PR/R, PB/B, Y/G)</i>	No
	HDMI	No
S-Video <i>or S-Video on supplied scart (Europe)</i>	S-Video	Yes
	Composite <i>yellow connector</i>	No <i>will only show black & white image</i>
	RGB <i>(PR/R, PB/B, Y/G)</i>	No
	HDMI	No
RGB <i>(PR/R, PB/B, Y/G)</i>	Composite <i>yellow connector</i>	No
	S-Video	No
	RGB <i>(PR/R, PB/B, Y/G)</i>	Yes
	HDMI	No

Note for Europe:

In order to get the best video recording quality on the TV+ (RGB), you may need to set your tuner device's scart output to exit an RGB signal. Check your tuner's manual.

Note for HDMI Connections:

- *Europe* : Since the HDMI output connection does not allow a pass-through from any of the analog inputs, ARCHOS recommends that you connect your tuner's primary scart output directly to your television and the auxiliary (secondary) scart output to the TV⁺ inputs. In this case, you would not use the analog output connectors of the TV⁺.
- *North America*: Since the HDMI output connection does not allow a pass-through from any of the analog inputs, ARCHOS recommends that you connect one of your tuner's video outputs directly to the TV and a secondary video output to the TV⁺ inputs. In this case, you would not use the analog output connectors of the TV⁺.

8.3 CONNECTING WITH A TV ONLY (NO EXTERNAL TUNER)

- If your television has output connectors in addition to the inputs, you will be able to record from your television. Connect the TV's audio/video outputs to the inputs of the TV⁺.
- With this setup, you will only be able to record the channel that is currently displayed on the screen. You will also not be able to use the TV Program Guide or the scheduler.

9. THE TV PROGRAM GUIDE



With the ARCHOS TV Program Guide (EPG), you will be able to schedule recordings easily. The TV program guide service is free for the first year. More details and country eligibility at www.archos.com.

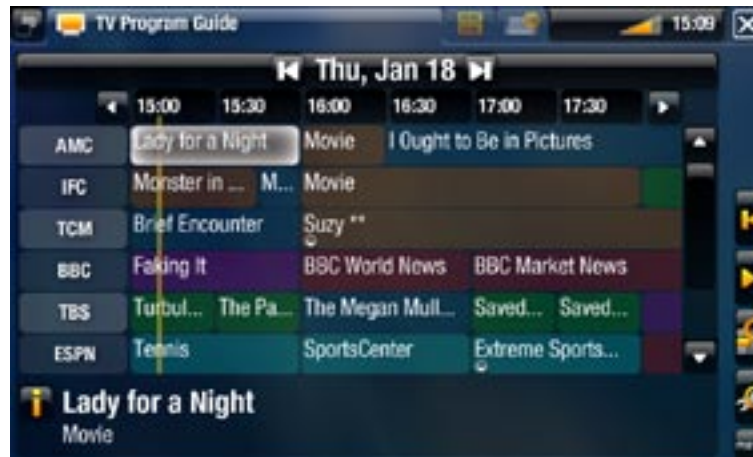

9.1 WHAT'S REQUIRED TO USE THIS FUNCTION?

- In order to use this functionality, you will need to connect the powered ARCHOS to a tuner, which can be either:
 - a satellite receiver
 - a Digital TV receiver
 - a cable/DSL box
 - a VCR
 - a DVD Recorder
- See: TV Recording: Hardware Setup.

Your tuner will need to be connected to your home antenna/satellite/cable.

9.2 ACTIVATING THE TV PROGRAM GUIDE ONLINE

After having connected the ARCHOS to your home television system, you will need to activate the TV Program Guide (EPG) online. This is a one-time operation.

1. Go to www.archos.com/register
2. Access your ARCHOS account (or create one if you don't have one yet) and register your ARCHOS. If you have already registered your ARCHOS, find the line that matches your product and click on **More...** (on the right).
3. Follow the instructions to activate the TV Program Guide.

9.3 TRANSFERRING THE PROGRAM DATA TO THE ARCHOS

Once you have activated the TV Program Guide online, you now need to transfer its data onto your ARCHOS. In order to do that, your ARCHOS needs to be connected to the internet.

First time Procedure

1. Turn on your ARCHOS device.
 2. From the Home screen, select the "**Recorder**" icon.
 3. Select the "**Update**" menu item. Your ARCHOS will automatically connect to a configured network.
- ✓ If your ARCHOS finds a configured WiFi / Ethernet network and if you have correctly activated the TV Program Guide online, the TV Program data will start updating automatically. This operation can take several minutes.

Do not try to operate the device while it is downloading TV Program information.

Updating the TV Program Guide periodically

- Every time you transfer the TV Program Guide information to the ARCHOS, your device will memorize all the TV Programs within a certain period of time.
- Remember to update the data periodically: the ARCHOS will remind you to update your TV Guide before it becomes obsolete (select the "**Settings**" menu item if you want to set the update reminder).
- You also have the possibility to let the ARCHOS automatically update the TV Program Guide information at night:
 - Select the "**Settings**" menu item and set the "**Automatic Updates**" parameter to "**On**".

9.4 CONFIGURING THE TV CONTROL SETTINGS

- From the ARCHOS Home Screen, select the "**Settings**" menu item, and choose "**TV Control**" to display the "**TV Control**" settings screen.
- This settings screen allows you to set the ARCHOS' IR emitter as well as configure the channel list.

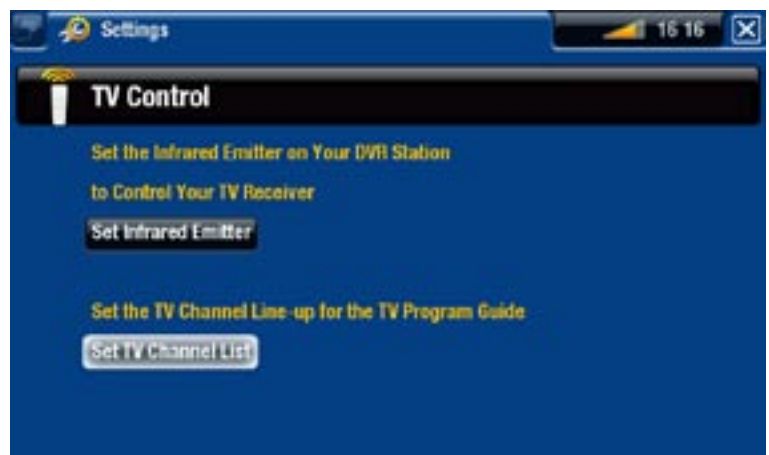

VERIFYING THE CHANNEL LIST

1. From the "TV Control" screen, select "**Set TV Channel List**".
2. Verify that the channel list on the ARCHOS is the same as on your tuner.
3. Here you can deselect/select a channel or change the number of a channel.

SETTING THE IR EMITTER

- The ARCHOS has a high-powered infrared LED, located on the front of the device, at the same place as the infrared receiver.



- It allows your ARCHOS TV+ to communicate with your tuner (VCR, cable box, satellite receiver or Digital TV receiver), so that it can turn it on and off, and change channels on it.
- This is a one time step to set your ARCHOS device to send the correct infrared codes to control your tuner. If you do not plan on making scheduled recordings, then you do not need to set the infrared emitter code.

1st Test: turning your tuner off

1. From the "TV Control" screen, select "**Set Infrared Emitter**". This first screen allows you to correctly set the codes and parameters so that the ARCHOS can turn your tuner on/off automatically (for a scheduled recording).



2. "**TV Receiver**": select the type of tuner that you want to control with the IR Emitter ("**VCR**", "**Cable/DSL box**", "**Satellite Receiver**", "**DVD Recorder**" or "**Digital TV**").
3. "**Receiver brand**": choose the brand of your tuner. You can use the Accelerator buttons \rightarrow \leftarrow on the remote control to scroll the list faster.

4. Select the **"Test power Off code"** button. Make sure that your tuner is on. Your ARCHOS device will then try to turn your tuner off. After a few seconds, your ARCHOS will ask you if the device responded correctly:
 - ✓ If your tuner turned off, select **"Yes"**, and move on to the next section.
 - ☒ If your tuner did not turn off, select **"No, try next code"**. Your device will try turning the tuner off again, using a different code. Repeat this operation until the ARCHOS manages to turn the tuner off.

If none of the codes work, check that the ARCHOS is positioned in a way that allows the infrared signal to reach your tuner's receiver. Note: In some rare cases the ON/OFF functionality may not work.

2nd Test: changing channels on your tuner

After you select **"Yes"** at the end of the 1st test, the following screen appears. It allows you to correctly set the parameters so that the ARCHOS can change channels on your tuner (for a scheduled recording).



1. For the **"Channel"** parameter, select the highest channel that is currently memorized on your tuner.
2. Select the **"Test channel select"** button. Make sure that your tuner is on. Your ARCHOS device will then attempt to switch your tuner to the selected channel. After a few seconds, your ARCHOS will ask you if the device responded correctly:
 - ✓ If this worked, select **"Yes"**.
 - ☒ If this did not work, select **"No, try next option"**. Your device will try again to switch your tuner to the selected channel, using a different option*. Repeat this operation until it successfully changes the channel on your TV receiver.

*Here is a description of the different parameters automatically set by the ARCHOS:

- **"Key Delay"**: delay between the emission of each digit of a channel (**"Short"**, **"Normal"**, **"Long"**).
- **"Key: Enter"**: Set to **"On"** if normally, you have to press an **"OK"** button on your tuner's remote control after you enter the channel number. Example: If you normally press 1, 3, **"OK"** to access channel 13, then this parameter is set to **"On"**.

- **“Key: -/--”**: Set to **“On”** if normally, you need to press a special key on your tuner’s remote control before entering a channel with several digit numbers (that is to say a channel greater than 9). This key is often represented with this symbol: **“-/--”**.
- **“Switches on with”**: see below.
- **“Time until video”**: see below.

If the ARCHOS did not manage to switch your tuner to the selected channel, you can try using a different ON/OFF code (see: 1st Test: turning your tuner off) and do the 2nd test again.

3. After you selected **“Yes”** at the end of the 2nd step, the following screen appears. You will have to set these two parameters:



- **“Switches on with”**: this depends on what key you normally press, on your tuner’s remote control, to turn it on. If you normally press the **“Power”** key, select **“Power”**. If you can press any channel key, then select **“Any channel”**. If you can press any key, select **“Any key”**.
- **“Time until video”**: select the amount of time it normally takes between the moment you turn on your tuner, and the moment the image appears on your TV (**“0...10 seconds”**, **“10...30 seconds”**, **“>30 seconds”**).

4. When you have finished, select **“Done”**, and a confirmation message will appear. Select **“OK”**.

9.5 SCHEDULING YOUR RECORDING

1. In the Home screen, select the **“Recorder”** icon to display the ARCHOS TV Program Guide.
2. This screen’s menu items will allow you to choose a different day, update the Program Guide data, or change various settings (program guide update and channel list configuration).



3. Navigate through the different TV programs, and simply select the one you wish to record.
4. A new window will appear with a description of the TV program. Select “**Record**”.
5. You will go back to the TV Program Guide and a ‘**REC**’ icon will now appear next to the TV Program you selected.

10. OTHER RECORDING FUNCTIONS

10.1 THE "TV SCHEDULER"

With the tuner connected to your ARCHOS (see: *TV Recording: Hardware Setup*), you can schedule recordings manually. If you want to schedule via the TV Program Guide, see *The TV Program Guide*.

- From the ARCHOS Home Screen, select the "**Recorder**" icon, and switch to the "**TV Scheduler**" tab (Tab button ).

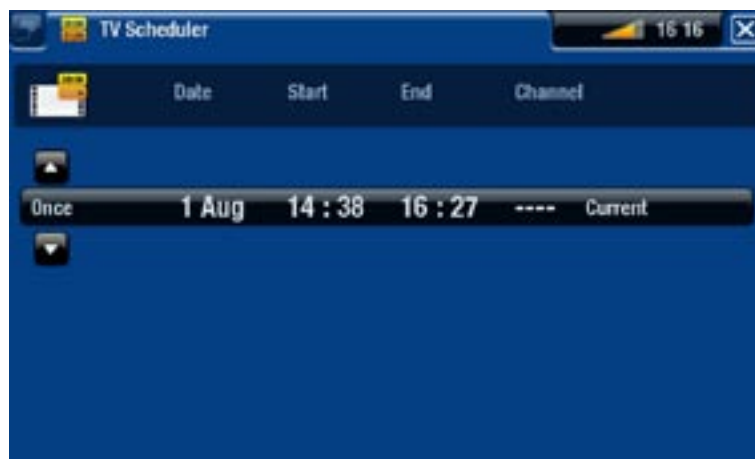

- This screen allows you to view, edit and schedule your recordings.
- Here you can schedule a new recording or edit an existing one: you can remove it, edit its title, change the time, date, channel, etc. You also have the possibility to add a safety margin to the beginning/end of the scheduled recording. To set this parameter, use the "**Settings**" menu item.

NOTES ABOUT THE SCHEDULER

- The scheduler automatically reorganizes the recording events chronologically.
- If you are listening to music, watching a video or looking at photos with the device, it will not interrupt you to make the scheduled recording.
- Once the scheduled recording has been made, or the date of a recording has been passed without the recording having been made, the schedule entry will be erased from the scheduler.

10.2 RECORDING VIDEO MANUALLY



With the tuner connected to your ARCHOS (see: *TV Recording: Hardware Setup*), you can schedule recordings manually. If you want to schedule via the TV Program Guide, see *The TV Program Guide*.

RECORDING PROCEDURE

1. In the Home screen, select the **"Recorder"** icon and use the Tab button  to access the **"Video Recorder"** mode.
2. This screen will allow you to adjust the recording sound gain (left/right arrows) as well as configure other recording parameters (see next section).
3. You can now start a video recording by pressing the **OK** button. You can pause and resume your recording at any time (**OK** button).



4. Close the screen **X** to stop and save the recording*. The automatic stop setting (**"Auto Stop Rec"**) is preset to 2 hours.

** All video recordings made by your ARCHOS device are saved in the Video/ (Rec) folder. If you wish to keep them in a different location, you can use the "Move" function of the ARCHOS file browser after recording.*

"VIDEO RECORDER" SETTINGS

To access the **"Video recorder"** settings screen, select the **"Settings"** menu item:

- **"Auto Stop Rec"**: the duration of time after which the ARCHOS will automatically stop recording. If you disable this function, the recording will continue until you press **X** or until the entire hard drive fills up.
- **"Rename"**: allows you to define the filename before the recording begins, using the remote control's keyboard.
- **"Source"**: you can choose which video input (**"Auto"**/**"Composite"**/**"S-Video"**/**"Scart"**/**"Component"**/**"RGB"**) you want the ARCHOS to use. Normally, with a good video signal, you can set it to **"Auto"** and your ARCHOS will scan its inputs to see which one is receiving video.
- **"Format"**: **"Auto"**/**"4:3"**/**"5:3"**/**"16:9"**/**"2.35"**. This is the aspect ratio of the screen that the ARCHOS device will record. You can set this manually, but in most cases you can just leave it on **"Auto"**.
- **"Widescreen"**: **"Auto"**/**"On"**/**"Off"**. If your tuner (cable box, satellite receiver, etc.) outputs a video signal in widescreen, you can force the ARCHOS to recognize this signal. This should be set to **"On"** if recordings show people that look unusually tall and thin. But in most cases you can just leave it on **"Auto"**.

- **"Bitrate"**: **500kb/s, 1000kb/s, 1500kb/s, 2000kb/s, 2500kb/s**. Use this to set the encoding quality. The higher the encoding rate, the higher the image quality but also more hard drive space will be used.
- **"Sampling"**: **32kHz, 48kHz**. This is the sound sampling rate. The higher value gives a higher quality sound but will take up more space on the hard drive.
- **"Contrast"**: adjusts the recorded image contrast.
- **"Brightness"** *: adjusts the recorded image brightness.
- **"Saturation"** *: use this to de-emphasize or saturate the colors in the recorded image.
- **"Hue"** *: changes the color spectrum in the recorded image.
- **"RGB settings"** *: **"Automatic"/ "Manual"**. Allows you to adjust the 3 RGB color levels (only when the source outputs an RGB signal).
- **"Blue saturation"** *: Adjusts the level of blue (only when the source outputs a component signal).
- **"Red saturation"** *: Adjusts the level of red (only when the source outputs a component signal).
- **"Reset"**: changes the above settings to the default values.

* These parameters will vary according to which type of signals are present on the TV* inputs.

COPY PROTECTION

- The ARCHOS recording system is designed to respect the Macrovision™ copyright protection system. If the source of your video is copy-protected, the device will record in protected mode. You will see a 'P' icon on the recording screen (not during playback), indicating that the file will be a protected file.
- Protected files can only be played back on the ARCHOS that created them, and not on a computer. The playback of protected files is also limited to the HDMI/HDCP video output (in this case, your TV must have an HDMI/HDCP input connector). It cannot be displayed on a television using any other video output type.

10.3 RECORDING AUDIO MANUALLY



With the ARCHOS, you have the possibility to record audio from most any standard audio source (hi-fi, turntable, boombox, etc).

RECORDING PROCEDURE

1. Connect your audio source's outputs to the ARCHOS' inputs.

2. In the Home screen, select the “**Recorder**” icon and use the tabs (☐ button) to access the “**Video Recorder**” mode. Then select the “**Audio Recorder**” menu item.
3. This screen will allow you to adjust the recording sound gain (left/right arrows) as well as configure other recording parameters (*see next section*).
4. Start the recording by pressing the **OK** button. You can pause and resume your recording at any time (**OK** button).
5. Close the screen **X** to stop and save the recording*.

** All audio recordings made by your ARCHOS device are saved in the Music/ (Rec) folder. If you wish to keep them in a different location, you can use the “Move” function of the ARCHOS file browser after recording.*

“AUDIO RECORDER” SETTINGS

To access the “**Audio Recorder**” settings screen, select the “**Settings**” menu item:

- “Set Title”: *allows you to give a personalized title to the recording, using the remote control’s keyboard.*
- “Format”: *you can choose between “PCM” (uncompressed) and “ADPCM” (compressed) WAV format.*
- “Sampling”: *choose the sample rate for your recording (a higher rate gives higher sound quality but a larger file).*

Be careful that the audio source is supplying a line-level and not an amplified signal. A signal that is amplified too much will result in a terribly distorted recording.



10.4 EDITING YOUR RECORDINGS

- Video files recorded with the ARCHOS can be edited by deleting the sections you do not wish included. The editing you can do is either cropping or cutting of particular segments of the video file.
- You will mark a segment of your video file, and then you will tell the ARCHOS to delete everything except the marked segment or to delete the marked segment from the video file. These operations can be done multiple times on the same video file.
- Once finished, you will have the option to save the edit marks with the video or to write a new video file. If you save your file with edit marks, you can always go back and change your edits at another time. The actual video information is not deleted. On the other hand, you can write a new file which will only include the video parts that you specified in the edit session. This file will be smaller but you can never un-edit it.

EXAMPLE 1

You have recorded a music video program and would like to keep one single music presentation. But you do not want to keep the rest of the television recording.









1. Open the video file you want to edit and pause it.
2. In the progression bar, go to the beginning of the desired section (a), select the **"Insert a mark"**  menu item, and choose **"Start Mark"**.
3. Forward to the end of the desired section (b), select the **"Insert a mark"**  menu item, and choose **"End Mark"**.
4. Select the **"Edit Selection"**  menu item and choose **"Crop"**, which will delete everything except the designated section.

EXAMPLE 2

You have recorded a television program but would like to remove certain sections before the program started, parts during the program, and the program afterwards because you had recorded a little extra.



1. Open the video file you want to edit and pause it.
2. In the progression bar, go to the beginning of the first undesired section (a), select the **"Insert a mark"**  menu item, and choose **"Start Mark"**. Forward to the end of the first undesired section (b), select the **"Insert a mark"**  menu item, and choose **"End Mark"**. Select the **"Edit Selection"**  menu item and choose **"Cut"**, which will cut out this part of the recording.
3. Go to the beginning of the second undesired section (c), select the **"Insert a mark"**  menu item, and choose **"Start Mark"**. Forward to the end of the second undesired section (d), select the **"Insert a mark"**  menu item, and choose **"End Mark"**. Select the **"Edit Selection"**  menu item and choose **"Cut"**, which will cut out this section.
4. Do the same for the other section(s) that you want to cut out.

- *If you want to keep the edit points and be able to re-edit another time, select the “Save edit” menu item, and choose “Save”.*
- *If you want to save the edited file as a new individual file, select the “Save edit” menu item, and choose “Write to new File”. A confirmation screen will pop up.*
- *If you want to cancel the edit points and restart editing, choose the “Cancel changes and restart edit” menu item.*

TROUBLESHOOTING

RESTARTING / RESETTING YOUR ARCHOS

- In the event that your ARCHOS freezes or does not respond anymore, disconnect the power adapter, wait for 15 seconds and reconnect it. When the red LED indicator stops blinking, press the Power button  on the supplied remote control to turn on your device.
- ONLY use the Reset button, on the back of the device, if you need to relaunch the Installation Wizard. When you press this button, the ARCHOS will restart and a message will pop up to confirm the relaunch of the wizard. If you do not respond within 10 seconds, the wizard will be automatically relaunched. See: *The Installation Wizard*.

ATTENTION: if you use the reset button and relaunch the wizard, no data will be erased but your TV connection settings will be lost, and you will have to set them up again through the wizard.

SYSTEM RECOVERY

- If your ARCHOS does not respond correctly, or does not show certain songs or videos that you have copied to it, try using the **"Repair and Formatting Tools"** (see: *System Settings*).
 - If using the **"Repair and Formatting Tools"** does not solve your problem, you can try a system recovery. It allows you to repair the hard drive, format it, etc.
1. Restart your device (disconnect the power adapter / wait for 15 seconds / reconnect it).
 2. The red indicator starts blinking, and after a few seconds, it will start blinking faster. While the red indicator is blinking faster, press the **TV** button on the remote control to access the Recovery mode.

If the image does not appear, press the TV button and wait for a few seconds. Repeat this operation until you can see the recovery screen (white background).

While you are in recovery mode, use the navigation buttons of the remote control to move from one option to another and press **OK** to validate.

FORCING THE FIRMWARE UPDATE

To update the firmware, always try to do it as explained in the section: *Updating the Firmware*. If this does not work, you can force the firmware update (first screen of the recovery mode):

“No”

- cancels the firmware update and brings you to the second screen of the recovery mode.

“Yes”

- follow the on-screen instructions to force the firmware update. You will need to connect a USB key to the ARCHOS' host port (the firmware .AOS file must be located at the root of the USB key).

FORCING THE SYSTEM RECOVERY

If you select **“No”** in the first screen of the recovery mode, a second screen appears, giving you 3 options:

“No”

- cancels the system recovery.

“Repair Disk”

- attempts to repair the file structure on the hard drive.
- does not erase any data.

“Format Disk”

- formats the hard drive.
- all data (music, photos, videos, etc.), licenses and settings are erased.

REPAIR AND FORMATTING TOOLS

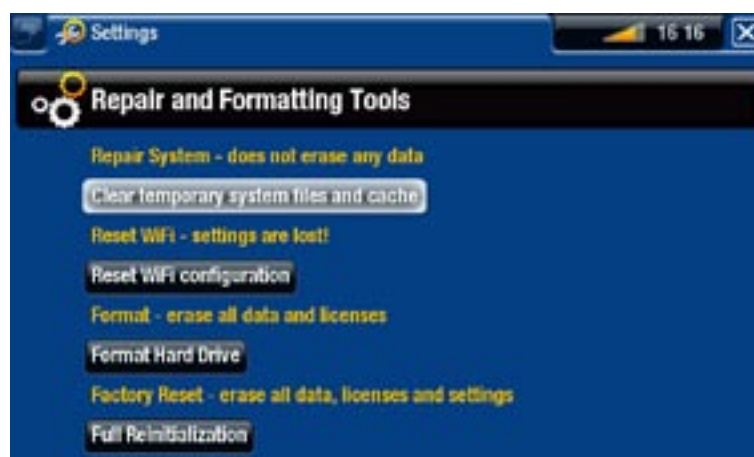

- to access the **“Repair and Formatting Tools”** settings screen: from the Home screen, select the **“Settings”** menu item, choose **“System”**, then use the **“Repair and Formatting Tools”** button. This screen allows you to do the following actions:
- **“Clear temporary system files and cache”** (does not erase any data)
- **“Reset Settings”** (resets all user settings)
- **“Format Hard Drive”** (erase all data, media files, and licenses)
- **“Full Reinitialization”** (erase all data, media files, licenses and settings)

In the event that your ARCHOS freezes or does not respond anymore, try to reset it (see: Restarting / Resetting your ARCHOS).

If this does not work or if you cannot access the Repair and Formatting Tools, you can try a system recovery (see: System Recovery).

TECHNICAL SPECIFICATIONS

HARD DRIVE CAPACITY

- See *packaging*.

VIDEO PLAYBACK**

- MPEG-4⁽⁴⁾ (ASP@L5 AVI, up to DVD resolution)
- WMV (MP@ML, up to DVD resolution)
- With optional software plug-ins (available on www.archos.com):
 - Podcast plug-in: H.264 up to DVD resolution and AAC sound.
 - Cinema Plug-in: MPEG-2 MP@ML up to 10 Mbps (up to DVD resolution) and AC3 stereo sound.

AUDIO PLAYBACK**

- Stereo MP3 decoding @ 30-320 Kbits/s CBR & VBR, WMA, Protected WMA, WAV (PCM/ADPCM).
- With optional software plug-ins (available on www.archos.com):
 - AAC⁽⁵⁾ stereo audio files
 - AC3 stereo audio files

PHOTO VIEWER***

- JPEG, BMP, PNG, GIF

PDF VIEWER

- Reads PDF documents (may not implement all PDF features)

VIDEO RECORDING⁽⁶⁾

- Records NTSC/PAL/SECAM to MPEG-4 SP files with ADPCM stereo sound, VGA resolution (640 x 480) @ 30 or 25 f/s, in AVI format.

AUDIO RECORDING

- In WAV (IMA ADPCM or PCM) format.

INTERFACES

- USB 2.0 High-Speed Device (compatible USB 1.1): Mass Storage Class (MSC) and Media Transport Protocol (MTP).
- USB 2.0 Host : Mass Storage Class (MSC) and Picture Transfer Protocol (PTP)

CONNECTIONS

- WiFi (802.11g) connection. Optional Web Browser plug-ins for web browsing (available on www.archos.com)
- INPUTS :
 - Audio: stereo analog
 - Video: composite, S-video, RGB, YPbPr (component)
 - Miscellaneous: Ethernet, USB slave (USB B), USB host (USB A), infrared receptor for remote control, and DC-in
- OUTPUTS:
 - Audio: stereo analog, SPDIF (RCA type)
 - Video: composite, S-video, RGB, YPbPr, and HDMI
 - Miscellaneous: infrared emitter, AV Switch

POWER SOURCE

- External: Power supply

FIRMWARE

- Device automatically downloads latest firmware updates

PACKAGE INCLUDES

- For North America: remote control, power supply (US plug), 2 audio RCA/RCA cables, 2 x S-Video cables, User guide, Connection sheet, Legal and safety notice, warranty sheet
- For Europe: remote control, power supply (EU/UK plugs), RCA/SCART Output cable, RCA/SCART Input cable, User guide, Connection sheet, Legal and safety notice, warranty sheet

*** Certain bitrates, resolutions, and/or file variations may not be compatible.*

**** Certain resolutions and file sizes may not be compatible.*

(4) (MPEG-4: ISO standard by Moving Picture Experts Group; AVI: audio/video file container by Microsoft) without GMC and Quarter Pixel and WMV (including protected WMV).

(5) Does not read AAC protected files.

(6) Macrovision®-protected files can only be played back on the ARCHOS that created them, and not on a computer. The playback of protected files is also limited to the HDMI/HDCP video output (in this case, your TV must have an HDMI/HDCP input connector). It cannot be displayed on a television using any other video output type.

TECHNICAL SUPPORT INFORMATION

Need Help? You can find the information you need:

- On our Website: see the frequently asked questions section on www.archos.com/faq
- By asking our technical support team: visit www.archos.com/support for e-mail support.
- U.S. & Canada: Call 877-300-8879 (toll free).

All brands and product names are registered trademarks and the property of their respective owners. Windows Media® and Windows® are trademarks or registered trademarks of Microsoft Corporation in the United States and/or other countries. Specifications are subject to change without notice. Errors or omissions excepted. Images and illustrations may not always match contents. All the information contained in this guide was correct at the time of publication.

COPYRIGHT ARCHOS © 2007. All rights reserved.